

STATE OF OKLAHOMA
UNIFORM CRIME REPORT
ANNUAL REPORT
JANUARY—DECEMBER 2002

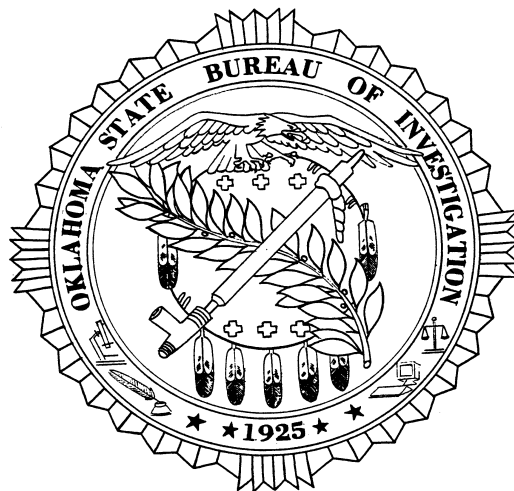

COMPILED BY THE
OKLAHOMA STATE BUREAU
OF
INVESTIGATION

This publication is issued by the Oklahoma State Bureau of Investigation as authorized by Director Tom Jordan. Nine hundred copies have been printed by Career Tech Printing Services, Stillwater, Oklahoma, at an approximate cost of \$2,461.03. Copies have been deposited with the Publications Clearinghouse of the Oklahoma Department of Libraries.

The Information Services Division and the Management of Information Services Division of the OSBI have prepared the publication "*Crime in Oklahoma.*" Persons directly responsible for the creation of this publication are listed below. Through their efforts, the data contained within this report was compiled and the design layout created.

Section Supervisor	Linda DeArman
Field Services Supervisor	Rodney Eaton
Field Services Unit	Freda Atkinson Greg Feuerborn Derrie Fox Mike Goodloe Sharon Maxwell Jenni McDaniel Kay Thurman Jenny Virden
CDC & A Unit Supervisor	Jon Steen
Data Entry Staff	Judy Burnside Cora Hollis Terry Miller Elizabeth Riccardi Claudette Scott
MIS Division Director	Ben Gherezgiher
MIS Staff	Jo Miller Jebessa Mosisa Michael Paul

A special note of appreciation is extended to the law enforcement administrators and UCR reporters in the 301 sheriffs' offices and police departments throughout Oklahoma, who made this data available. We would also like to acknowledge the Communications department and the Photo department of the Oklahoma State Capitol for making the publication cover design and the "*On the Cover*" article possible.

STATE OF OKLAHOMA

BRAD HENRY, GOVERNOR

BUREAU OF INVESTIGATION

TOM JORDAN, DIRECTOR

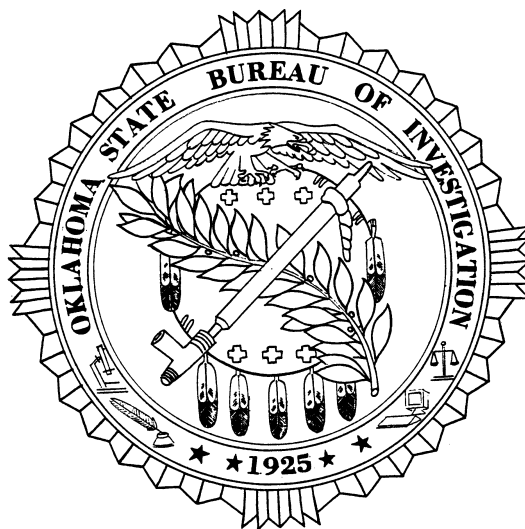

INFORMATION SERVICES DIVISION

RUSTY FEATHERSTONE, DIVISION DIRECTOR

FIELD SERVICES UNIT

RODNEY EATON, PROJECT DIRECTOR

6600 N. HARVEY
OKLAHOMA CITY, OK 73116
405-848-6724

TABLE OF CONTENTS

ON THE COVER.....	vii
OSBI COMMISSION.....	ix
DIRECTOR'S MESSAGE.....	x
INTRODUCTION.....	xi
SIBRS LAW ENFORCEMENT UPDATE.....	xii
I. CRIME SUMMARY.....	1-1
Index Crime Trends	
Index Crimes – A Ten-Year Comparison	
II. UNIFORM CRIME REPORTING PROGRAM.....	2-1
Legislative Mandate	
Objectives	
Uses of Criminal Justice Data	
Classification of UCR Offenses	
III. INDEX CRIME ANALYSIS.....	3-1
Index Crime Offenses	
Murder	
Rape	
Robbery	
Aggravated Assault	
Burglary	
Larceny	
Motor Vehicle Theft	
Arson	
IV. PROPERTY STOLEN AND RECOVERED.....	4-1
Property Value and Type	
V. ARREST AND CLEARANCE DATA.....	5-1
Arrest and Clearance Data	
Juvenile Arrest Overview	
Juvenile Arrests	
Collection of Dispositions	
Adult Arrests	
Arrests By County	

VI.	LAW ENFORCEMENT OFFICERS KILLED OR ASSAULTED.....	6-1
	Officers Killed or Assaulted	
	Law Enforcement Employee Data	
VII.	REPORTED RURAL CRIME.....	7-1
	Rural Index Crime Offenses	
VIII.	DOMESTIC ABUSE AND HATE/BIAS CRIMES.....	8-1
	Domestic Abuse	
	Hate/Bias Crimes	
IX.	INDEX CRIME OFFENSES BY CONTRIBUTOR.....	9-1
	Map-Index Crimes by County	
	Contributors	
	Alphabetical Agency Listing	
X.	CONTRIBUTOR PARTICIPATION.....	10-1
	History of Program Participation	
XI.	STATEMENT OF POLICY AND REGULATIONS.....	11-1
	Statement of Policy	
XII.	APPENDIX.....	12-1
	Statistical Variables	
	Glossary of Terms	

LIST OF TABLES

Index Crime Trends	1-2
Crime Clock.....	3-4
Murder by Age, Sex, and Race	3-7
Murder By Offense, Relationship, and Weapon.....	3-8
Robbery By Classification.....	3-11
Burglary By Classification	3-18
Larceny By Classification.....	3-20
Arson By Classification	3-25
Property Stolen - Recovered By Month.....	4-4
Clearance Data	5-4
Juvenile Arrests - A Ten -Year Comparison.....	5-5
Juvenile Arrests.....	5-8
Juvenile Dispositions	5-13
Adult Arrests.....	5-14
County Arrests By Category	5-19
Officer Assignment Information	6-2
Officer Assaults By Activity	6-3
Officer Assaults By Time	6-4
Officer Assaults By Weapon.....	6-5
Officer Injury Information	
Full-Time Law Enforcement and Civilian Employees.....	6-6
Domestic Abuse By Time of Day.....	8-3
Domestic Abuse By Day of Week.....	8-4
Domestic Abuse By Offense	
Hate/Bias Crimes.....	8-5
Type of Offense	
Type of Victim	
Number of Offenders	
Location of Incident	
Motivation	
Race of Offenders	
Index Crimes By County - Map.....	9-2
Alphabetical Agency Listing.....	9-4
Oklahoma Index Crime Offenses By Contributor.....	9-7
Contributor History.....	10-2

LIST OF GRAPHS

Index Crimes - A Ten -Year Comparison	1-5
Index Crime Offenses	3-2
Violent/Non -Violent Crime By Month	3-3
Murder By Month and Day of Week	3-6
Rape By Month, Forcible and Attempted	3-10
Robbery By Month and Weapon	3-12
Aggravated Assault By Month and Weapon	3-14
Burglary By Month and Type	3-16
Burglary - Residence and Non-Residence	3-17
Larceny Offenses By Month and Value	3-21
Motor Vehicle Theft By Month and Type.....	3-23
Value of Property Stolen and Recovered By Type	4-2
Value of Property Stolen - Recovered By Month; By Offense	4-3
Percentage of Index Crimes Cleared	5-3
Clearance By Age	5-4
Total Juvenile Arrests	5-5
Juvenile Index Crime Arrests; Weapons Law Violations.....	5-6
Juvenile Drug Related Arrests; Alcohol Related Arrests.....	5-7
Rural Violent Crimes - A Three-Year Comparison (Murder and Rape).....	7-2
Rural Robbery By Weapon; Aggravated Assault By Weapon	7-3
Rural Non-Violent Crimes - A Three-Year Comparison; Property Stolen and Recovered....	7-4
Rural Burglary By Type - Residence and Non-Residence By Time of Day.....	7-5
Rural Larceny By Value; Motor Vehicle Theft By Type	7-6
Domestic Abuse By Offense.....	8-2

ON THE COVER

Work began on the Capitol in Oklahoma City more than 80 years ago. The original neoclassical architectural plans called for a dome, but when the building was completed in 1917, there was no dome. For years people there have wondered why. Some theories are more colorful than others. There were stories that someone embezzled the funds or that the architect actually despised buildings with domes (in spite of the fact that the original blueprints called for one). One version is that the fledgling state ran out of money before the Capitol was finished. It's more likely that some of the funds were simply transferred to another project. That, too, is only conjecture, however, because no historical record exists to indicate exactly why the dome wasn't built.

The builders installed a circular stained glass piece in the central ceiling of the rotunda that gave the illusion of a dome from the inside. But from the outside, the omission was obvious. Although seven state capitols across the nation did not have domes, Oklahoma was the only one that was designed to have a dome, but didn't. While some citizens thought the missing dome detracted from the grandeur of the structure, others believed it looked just fine.

And so it stayed. In the late 1980s a group called The Capitol Domers tried to raise private funds to complete the dome. Although their initial enthusiasm was high, the group eventually ran out of steam long before enough money was raised. When Frank Keating was elected governor in 1994 he brought a renewed effort to raising money for the dome, a particular interest of his since he served in the Legislature some 25 years before. Eventually, the \$21 million needed to complete the project was raised.

Today, the finished dome stands 157-feet above the Capitol building. Construction was completed in late 2002 and the dome was dedicated on Statehood Day, November 16, 2002.

Senator Enoch Kelly Haney was selected to create the 17-foot statue of a young native warrior called "The Guardian" that was installed on the top of the dome. "The Guardian" holds a lance in his hand, with the spear-end piercing his legging and planted firmly in the ground, a stance that Haney says is highly symbolic of the Oklahoma people. Senator Haney did not accept the \$50,000 artist's commission for creating the sculpture. It was his family's gift to the people of Oklahoma. Senator Haney's son John, 12, and his grandson Enoch, 14, worked on the project with him, helping prepare clay for the piece.

This article is a condensed version of one written by Malia K. Bennett in December of 2001 and entitled "Finally, a Dome." Ms. Bennett, the Director of Communications for the Senate Committee at the State Capitol, also provided some of the photographs that appear on the back cover of the 2002 Annual Report. Stu Ostler, Chief Legislative Photographer at the State Capitol, took the front cover of the dome with flags. Erin McGregor, another Legislative Photographer, took the fireworks photograph that appears on the back cover.

OSBI COMMISSION

The OSBI Commission consists of one sheriff, one district attorney, one police chief, and four lay members. Each member is appointed by the Governor and approved by the Senate to serve a seven-year staggered term.

The Commission has five statutory responsibilities: to appoint the Director of the OSBI; to hear complaints against the OSBI or any of its employees; to make recommendations to the Director of any needed disciplinary action as a result of any investigation conducted upon a complaint received; to establish general procedures with regard to assisting law enforcement officers and district attorneys; and to establish a program of training for agents. The current Commission members are:

TED FARISS – CHAIRMAN, LAY MEMBER

Mr. Fariss is a farmer and rancher in Dewey County and is the Chief Operating Officer of the Bank of Western Oklahoma in Elk City. He was appointed to the Commission by Governor David Walters in 1994. He was reappointed by Governor Frank Keating in 2001.

STANLEY GLANZ – VICE CHAIRMAN, SHERIFF MEMBER

Mr. Glanz has served as the Sheriff of Tulsa County since 1989. He served 23 years at the Tulsa Police Department. He was appointed to the Commission by Governor Henry Bellmon in 1989. He was reappointed by Governor Frank Keating in 1995 and again in 2002.

RUSSELL NOBLE – LAY MEMBER

Mr. Noble is the President of the Sea Cattle Company and the Quien Sabe Corporation in Ardmore, Oklahoma. He is a trustee of the Samuel Roberts Noble Foundation. He was appointed to the Commission by Governor Frank Keating in 1997.

ANNE HOLZBEIERLEIN – LAY MEMBER

Ms. Holzbeierlein has many years of community service that includes the Edmond Board of Education, Edmond Women's Club, and the Women in Leadership Organization. She brings to the Commission experience in administration through the private sector. She was appointed to the Commission by Governor Brad Henry in 2003.

DONALD HUMPHREYS – LAY MEMBER

Mr. Humphreys works as an investigator in the legal department of the Oklahoma State Department of Health. He was appointed to the Commission by Governor Frank Keating in 1998.

ROB HUDSON – DISTRICT ATTORNEY MEMBER

Mr. Hudson is a District Attorney that serves Logan and Payne Counties. He was appointed to the Commission by Governor Frank Keating in 2002.

MICKEY PERRY – POLICE CHIEF MEMBER

Mr. Perry currently serves as police chief in Claremore. He is a veteran law enforcement official with 34 years of law enforcement experience, 11 of those with the Oklahoma Bureau of Narcotics. He is an active member of many professional organizations such as the Oklahoma Association of Chiefs of Police (OACP), Oklahoma Sheriffs and Peace Officers Association (OSPOA) and the International Association of Chiefs of Police (IACP). He was appointed to the Commission by Governor Brad Henry in 2003.



Oklahoma State Bureau of Investigation

THOMAS D. JORDAN
Acting Director

April 21, 2003

Dear Oklahomans:

The OSBI is now in their 29th year of providing crime statistical data to the citizens and criminal justice community through our Annual Report on Crime in Oklahoma. During 2002, Oklahoma has experienced an overall increase in violent crime over 2001 figures. However, murder in Oklahoma is down by 11.9% totaling 163 cases for the year, with aggravated assault dropping 3.2% for a total of 12,885 incidents occurring in 2002. Non-violent crimes were up by 4.6% with larceny (theft) showing the greatest increase of 6% over 2001 figures. Index Crimes reported being elevated by 4% for the year.

Recent international events have triggered a justified guarded posture by Oklahoma law enforcement officials. Federal, State, and local law enforcement authorities have experienced a heightened sense of awareness within their communities that sometimes proves frustrating, but they remain diligent in their safety and security responsibilities. The national economy also has affected the programs and resources needed by law enforcement in the fight against crime in our State. Despite tough economical times and the periodic threat of terrorism looming in the midst, law enforcement and criminal justice agencies throughout the State continue to provide the pro-active and re-active protective services to our citizenry that rivals any State in the country.

OSBI has always been a visionary organization utilizing state-of-the-art technology, well trained, educated, and experienced forensic and investigative personnel to assist in the perpetual fight against crime in Oklahoma. I pledge to all of our statutory requestors and the people of Oklahoma that this endeavor will continue into the future. I urge the people of Oklahoma and all law enforcement in the State to elevate our stand against criminal activity through mutual trust, preparedness, and professional networking of resources. Only through a unified effort can we become a paradigm that greatly enhances the chances of success.

OSBI remains predisposed in providing superior investigative, forensic, and support services to law enforcement agencies throughout the State of Oklahoma. Our commitment to making Oklahoma a safer environment for our family and friends to live in is paramount to our agency.

Please join me in recognizing our law enforcement officials in Oklahoma. We should all be proud of their valiant effort in the sometime overwhelming fight against crime.

Sincerely,

A handwritten signature in blue ink, appearing to read "Thomas D. Jordan".

Thomas D. Jordan
Acting Director

INTRODUCTION

BACKGROUND

The Uniform Crime Reporting Program (UCR) was conceived, developed, and implemented by law enforcement for the express purpose of serving as a tool for operational and administrative purposes. Under the auspices of the International Association of Chiefs of Police, the UCR Program was developed in 1930. Prior to that date, no comprehensive system of crime information on a national scale existed. This was primarily because criminal statutes varied so greatly from state to state in their use of terminology to define criminal behavior. To overcome this problem, a set of definitions for specific criminal acts was devised. These definitions were developed following an in-depth research effort relative to each of the state criminal extant statutes. It was determined that law enforcement agencies would tabulate the number of criminal acts as defined by the UCR Program as these acts were brought to their attention. Recognizing the problem of coping with sheer volume, it was decided that only those criminal acts deemed serious would be counted. It was necessary to define "serious." In this regard, a criminal act is considered serious if it meets a set of criteria; namely, that the act would occur regardless of geographical location; that it would be an offense most likely to be reported to law enforcement; that it would affront the moral sensitivities of our society's rational being; and that it would occur with sufficient frequency so that counting it would be worthwhile statistically.

STATE UCR PROGRAM

During that period of time when UCR was still a concept, it was recognized that individual states would also need crime information of particular interest to the state but of no great importance to the national view of crime. It was not until the latter part of the 1960's that funds became available for states to consider the development of their own individual reporting systems.

The purpose for a state UCR Program is multifaceted. First, with personnel administering a state program, more direct and meaningful contact with individual contributors is realized. Second, the ability to expand contributions exists due to state personnel being readily available to lend assistance. Third, mandatory participation ensures a law enforcement agency will either enhance an already existent records system or will install one capable of producing the needed data. Fourth, with state personnel reviewing information emanating from law enforcement contributors and this information being checked at the national level, the validity and completeness of data are further ensured. Fifth, individual state programs can address problems that are unique to the state.

The Oklahoma State Bureau of Investigation assumed the statewide administration of the UCR Program on September 1, 1973. This document is the twenty-ninth annual report, presenting statistical information collected and compiled through the year 2002 with a comparative analysis of the years 2001 and 2000.



Oklahoma State Bureau of Investigation

THOMAS D. JORDAN
Acting Director

June 27, 2003

LAW ENFORCEMENT BULLETIN SPECIAL REPORT

The Oklahoma State Bureau of Investigation (OSBI) continues with the previously announced development of a new era in crime reporting. The OSBI is currently in the process of changing the way crime statistics are collected in Oklahoma. The new reporting system is being designed on an incident based reporting (IBR) platform. This new system is called the State Incident Based Reporting System (SIBRS).

The OSBI assumed the statewide administration of crime reporting on September 1, 1973. Since that time, the state program has relied on the Uniform Crime Reporting (UCR) program for collection of crime statistics. The UCR program was developed in the 1930s and is still used by many law enforcement agencies today. The program has experienced few changes over the past 70 years. At best, this current UCR program reports only aggregate numbers of crime occurrences that allow law enforcement officials the ability to analyze trends in crime data. SIBRS will offer law enforcement more comprehensive data than ever before available.

SIBRS is an "Incident Based Reporting System" that allows for the collection of more specific data for each crime event than the current UCR "Summary" program. In March of 2002, the OSBI began the initial planning stages for SIBRS. The SIBRS project is currently in the development and testing stages and is progressing rapidly towards statewide implementation. For more information concerning SIBRS, please see us on the web at www.osbi.state.ok.us/sibrs. If you have any questions or comments, please contact Mr. Rodney Eaton, UCR Project Director at the OSBI, (405) 879-2533, or by email: rodneye@osbi.state.ok.us.

Respectfully,

A handwritten signature in red ink that reads "Rusty Featherstone". The signature is written in a cursive, flowing style.

Rusty Featherstone, Director
Information Services Division

I
INDEX
CRIME
SUMMARY

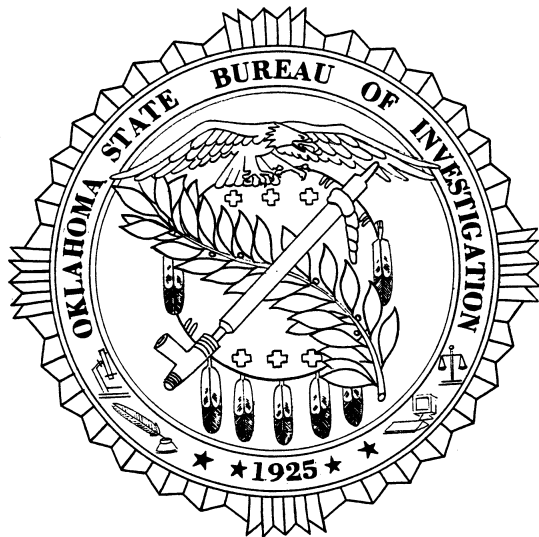

OKLAHOMA STATE BUREAU OF INVESTIGATION

INDEX CRIME TRENDS

This section presents a general overview of the crime data collected for the year 2002. The following sections of this report provide a detailed breakdown and analysis of crime related activities in Oklahoma for the past three years.

TYPE OF OFFENSES	YEAR	NUMBER OF OFFENSES	% CHANGE
MURDER	2002	163	-11.9
	2001	185	+2.2
	2000	181	-21.6
RAPE	2002	1,573	+5.9
	2001	1,486	+4.5
	2000	1,422	+3.1
ROBBERY	2002	2,966	+8.0
	2001	2,746	+5.0
	2000	2,615	-6.0
AGGRAVATED ASSAULT	2002	12,885	-3.2
	2001	13,308	+2.7
	2000	12,958	+2.2
VIOLENT CRIMES TOTAL	2002	17,587	-0.8
	2001	17,725	+3.2
	2000	17,176	+0.7
BURGLARY	2002	35,171	+1.7
	2001	34,569	+9.2
	2000	31,661	-8.1
LARCENY (THEFT)	2002	100,185	+6.0
	2001	94,527	-1.7
	2000	96,116	+2.7
AUTO THEFT	2002	12,772	+1.6
	2001	12,568	+1.8
	2000	12,348	+1.8
NON-VIOLENT CRIMES TOTAL	2002	148,128	+4.6
	2001	141,664	+1.1
	2000	140,125	-0.1
INDEX CRIMES * GRAND TOTAL	2002	165,715	+4.0
	2001	159,389	+1.3
	2000	157,301	+0.0

* A collection of statistics regarding arson is shown separately and is not reflected in the Index Offense totals in this publication. Totals on this report may not equal 100.0% due to rounding plus or minus variances of 0.1%.

OKLAHOMA STATE BUREAU OF INVESTIGATION

RATE OF INDEX CRIME

Index Crimes totaled 165,715 for 2002, constituting 4,743 offenses per 100,000 population. This represents an increase of 4.0% from those reported in 2001.

LARGEST CATEGORY OF INDEX CRIMES

The largest category reported in 2002 was larceny (theft) with 100,185 offenses. Property loss was valued at \$58,179,929. The number of thefts increased 6.0% from 2001, with a 3.8% increase in dollar loss.

VIOLENT CRIME

The number of violent crimes (murder, rape, robbery, and aggravated assault) decreased 0.8% from 2001.

NON-VIOLENT CRIME

Non-violent crimes (burglary [breaking and entering], larceny [theft], and auto or other motor vehicle theft) reflected an increase of 4.6% in 2002.

VALUE OF PROPERTY STOLEN

Stolen property valued at \$166,413,095 was reported in 2002; of that amount, 24.0% was recovered. The dollar loss increased by \$4,625,940 or 2.9% compared to 2001.

MURDERS

A total of 163 murders was reported in 2002, representing a decrease of 11.9% from 2001.

LAW ENFORCEMENT OFFICERS KILLED OR ASSAULTED

Zero (0) officers were killed in 2002 as the result of a felonious act.

Zero (0) officers were killed in 2002 as the result of an accident or negligent act.

Eight hundred forty-three (843) law enforcement officers were assaulted during 2002. Assaults on officers increased 3.3% from the 2001 figure of 816.

CRIME CLEARANCE

The clearance rate for all index crimes reported in 2002 was 17.9%; the rate for 2001 was 17.5%.

OKLAHOMA STATE BUREAU OF INVESTIGATION

ARRESTS FOR INDEX CRIMES

A total of 23,005 arrests was made for index crimes, constituting 13.8% of all arrests made in 2002.

A total of 166,395 arrests for all offenses was reported in 2002. This is an increase of 1,822 or 1.1% more arrests than were reported in 2001.

DRUG ABUSE ARRESTS

There were 22,097 arrests for drug abuse violations; of that number, 8.0% were persons under 18 years of age.

Possession of marijuana constituted 45.5% of the total drug abuse arrests, while sale of marijuana accounted for 4.9% of arrests. Possession of opium, cocaine and derivatives comprised 15.6% of the total drug abuse arrests; sale of opium, cocaine and derivatives equaled 3.1% of the total drug abuse arrests.

ALCOHOL RELATED ARRESTS

Alcohol related arrests (driving under the influence, drunkenness, and other liquor law violations) accounted for 30.0% of all arrests in 2002. This percentage represents the arrest of 47,817 adults and 2,068 juveniles.

RATIO OF LAW ENFORCEMENT EMPLOYEES

In 2002, there were 9,190 full-time law enforcement employees in Oklahoma, an increase of 0.5% from 2001. The police employee ratio was 2.6 employees per 1,000 inhabitants.

POPULATION

The estimated population in Oklahoma for 2002 was 3,493,714. This is a 1.2% increase from 2001.

LAW ENFORCEMENT AGENCY CONTRIBUTORS

The total number of law enforcement agencies contributing to the Uniform Crime Reporting Program in 2002 was 301. There were 299 contributing agencies in 2001.

OKLAHOMA STATE BUREAU OF INVESTIGATION

INDEX CRIMES - A TEN-YEAR COMPARISON

TOTAL INDEX CRIMES REPORTED

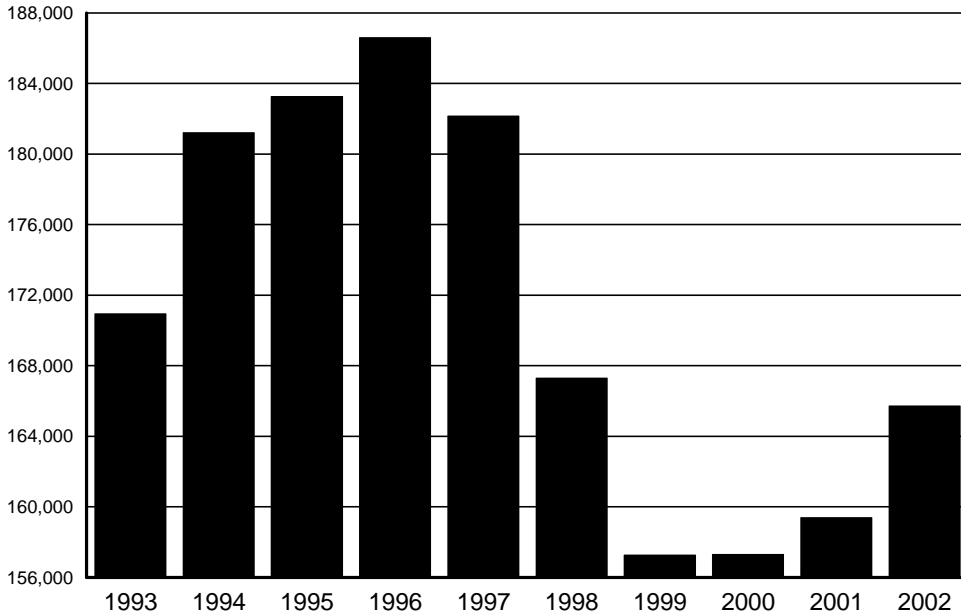

YEAR	TOTAL
1993	170,949
1994	181,204
1995	183,271
1996	186,600
1997	182,160
1998	167,295
1999	157,266
2000	157,301
2001	159,389
2002	165,715

The number of index crimes decreased 3.1% from 1993 to 2002. The largest total for this ten-year period occurred in 1996.

TOTAL VIOLENT CRIMES REPORTED

YEAR	TOTAL
1993	20,498
1994	21,196
1995	21,748
1996	19,710
1997	18,552
1998	18,038
1999	17,064
2000	17,176
2001	17,725
2002	17,587

There was a steady upward trend in the total number of violent crimes reported between 1993 and 1995. This trend reversed in 1996 with a decline of 19.1% from 1995 to 2002.

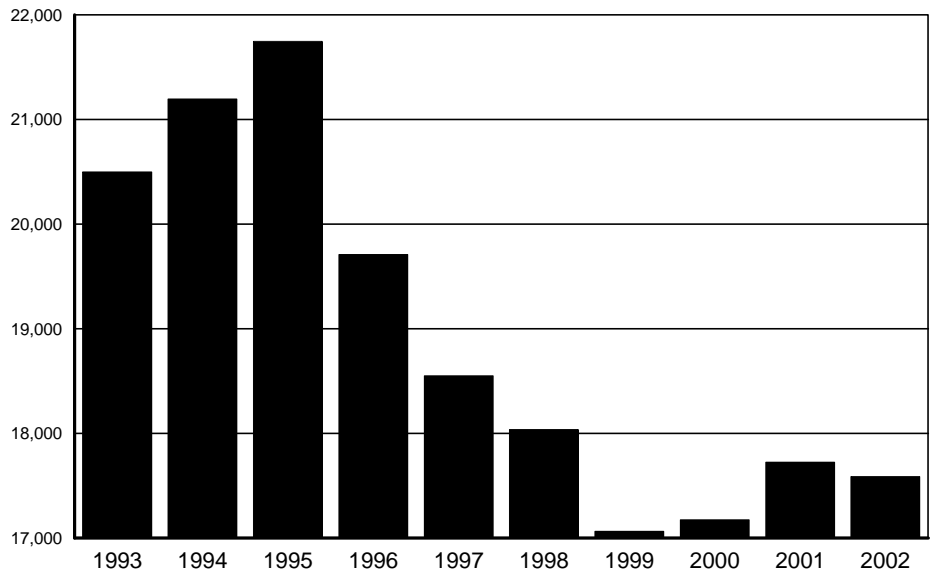

OKLAHOMA STATE BUREAU OF INVESTIGATION

MURDER

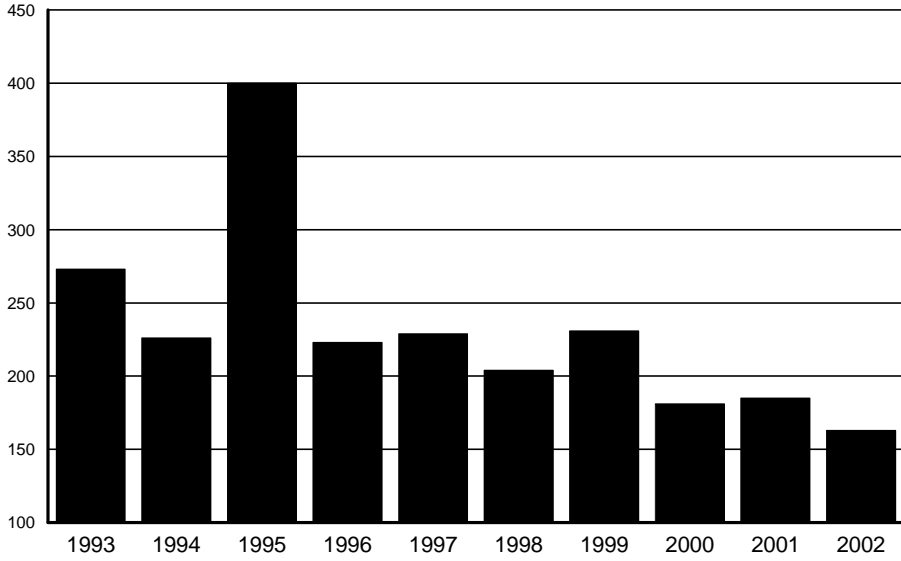

YEAR	TOTAL
1993	273
1994	226
1995	400
1996	223
1997	229
1998	204
1999	231
2000	181
2001	185
2002	163

1993 indicates the highest number of murders for the ten-year period, excluding 1995. The total for that year included the victims of the Alfred P. Murrah Federal Building bombing.

RAPE

YEAR	TOTAL
1993	1,590
1994	1,614
1995	1,460
1996	1,545
1997	1,517
1998	1,512
1999	1,379
2000	1,422
2001	1,486
2002	1,573

The 1994 figures were the highest for the ten-year period. The lowest figure in 1999 shows a decrease of 14.6% from the 1994 figures.

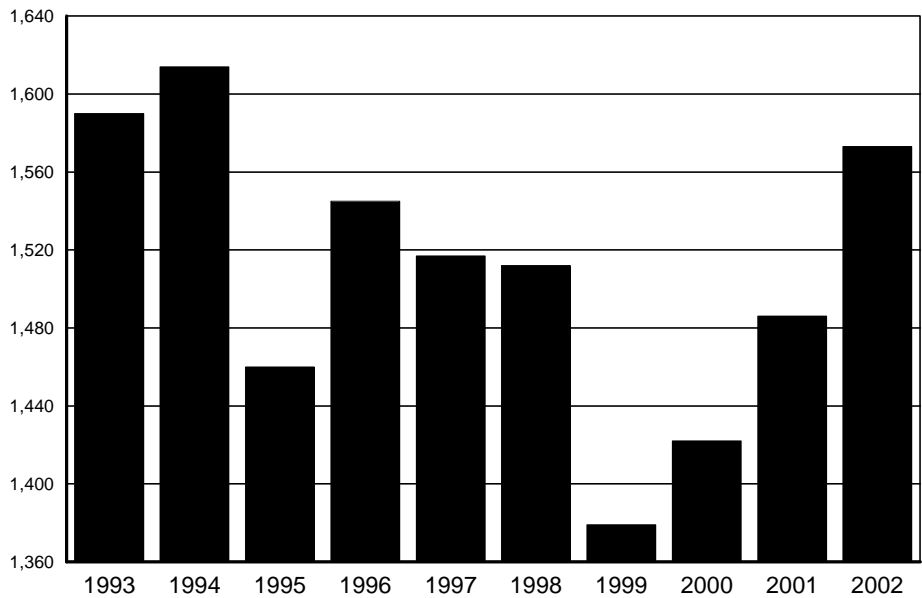

OKLAHOMA STATE BUREAU OF INVESTIGATION

ROBBERY

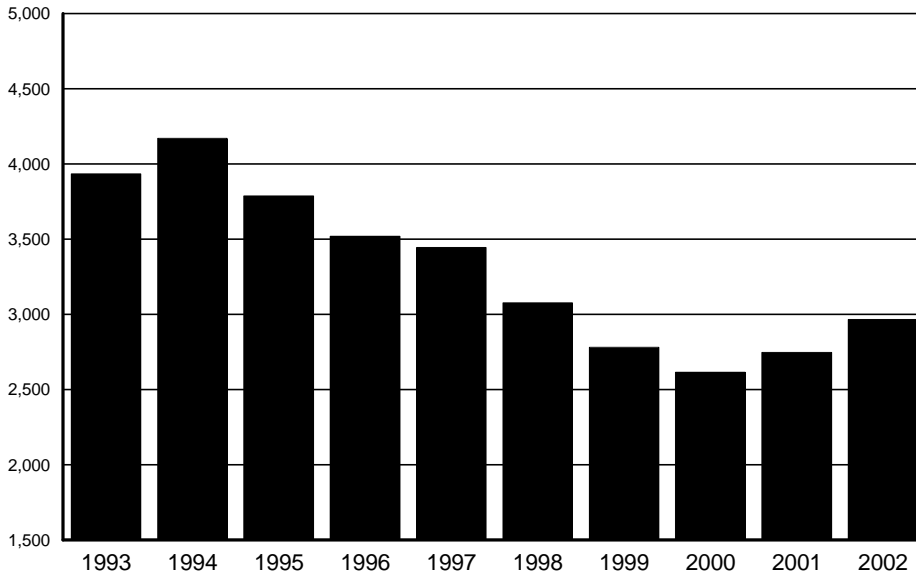

YEAR	TOTAL
1993	3,934
1994	4,171
1995	3,786
1996	3,519
1997	3,445
1998	3,076
1999	2,781
2000	2,615
2001	2,746
2002	2,966

In 2002, robberies decreased 24.6% from the number reported in 1993.

AGGRAVATED ASSAULT

YEAR	TOTAL
1993	14,701
1994	15,185
1995	16,102
1996	14,423
1997	13,361
1998	13,246
1999	12,673
2000	12,958
2001	13,308
2002	12,885

Aggravated assault reports increased consistently from 1993 through 1995. The 2002 figure indicates a 12.4% decrease in reports when compared to 1993, but it reflects a 20.0% decrease from 1995.

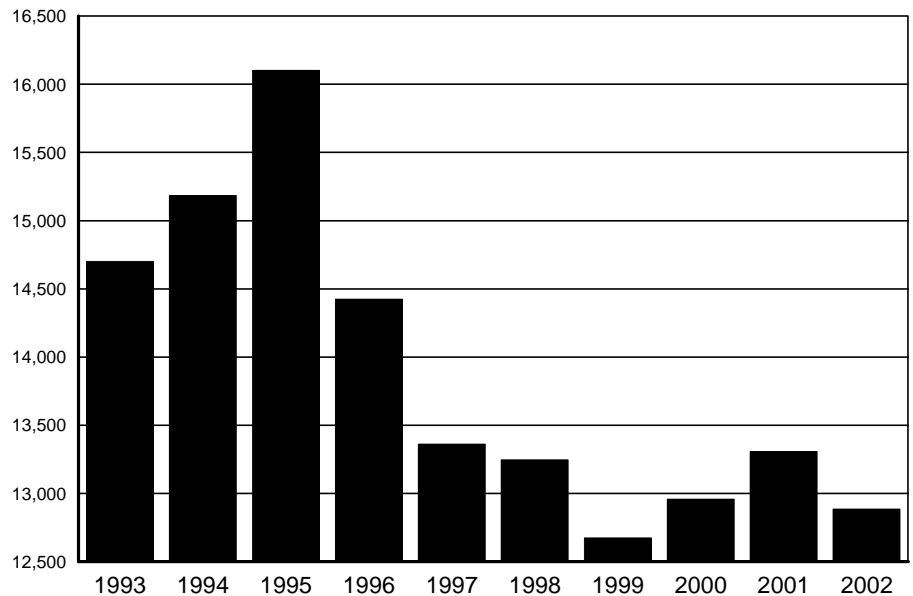

OKLAHOMA STATE BUREAU OF INVESTIGATION

NON - VIOLENT CRIME

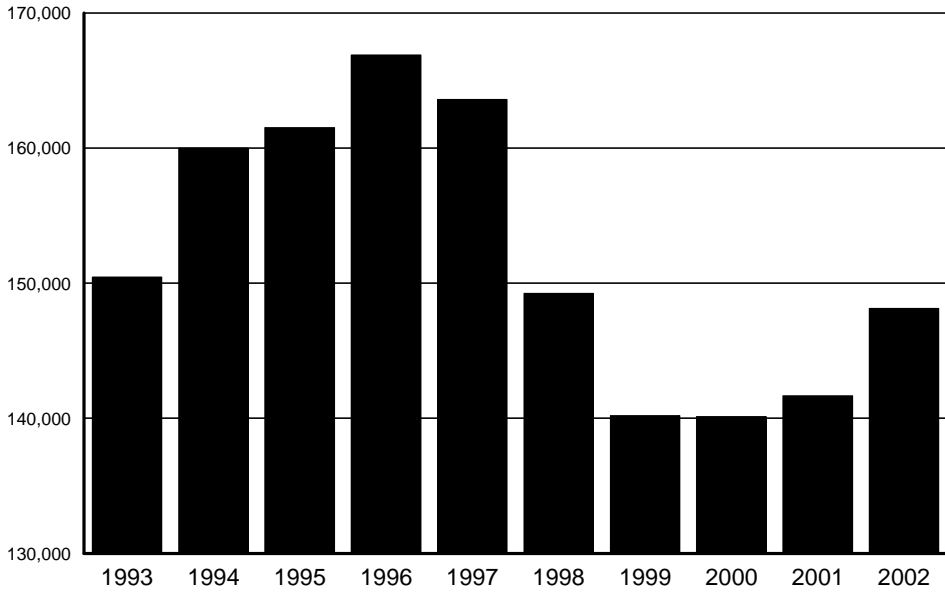

YEAR	TOTAL
1993	150,451
1994	160,008
1995	161,523
1996	166,890
1997	163,608
1998	149,257
1999	140,202
2000	140,125
2001	141,664
2002	148,128

The 2002 reported offenses were 11.2% lower than the highest figure in 1996.

BURGLARY

YEAR	TOTAL
1993	39,859
1994	40,700
1995	41,649
1996	41,445
1997	39,993
1998	38,224
1999	34,465
2000	31,661
2001	34,569
2002	35,171

Overall, the number of burglaries has declined since 1996.

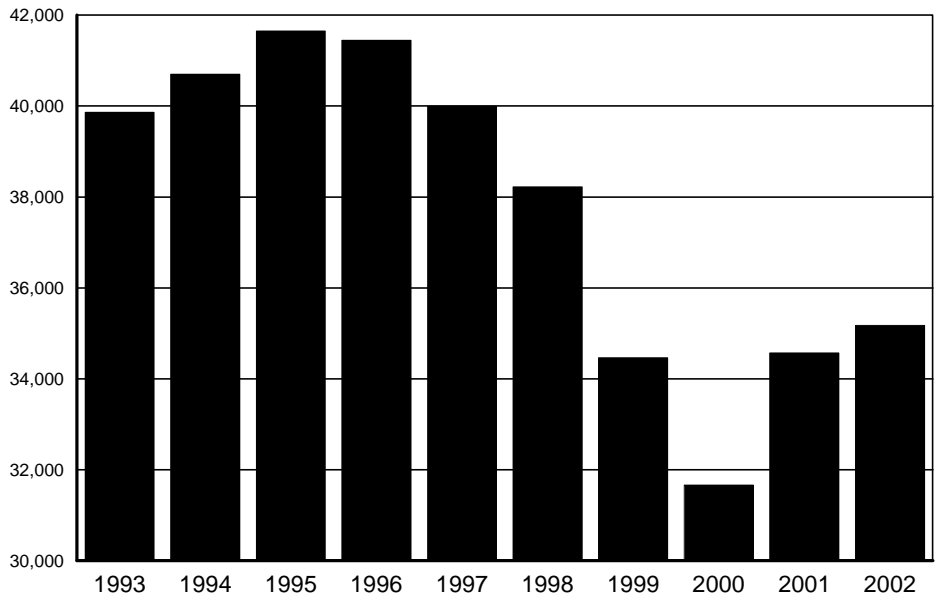

OKLAHOMA STATE BUREAU OF INVESTIGATION

LARCENY

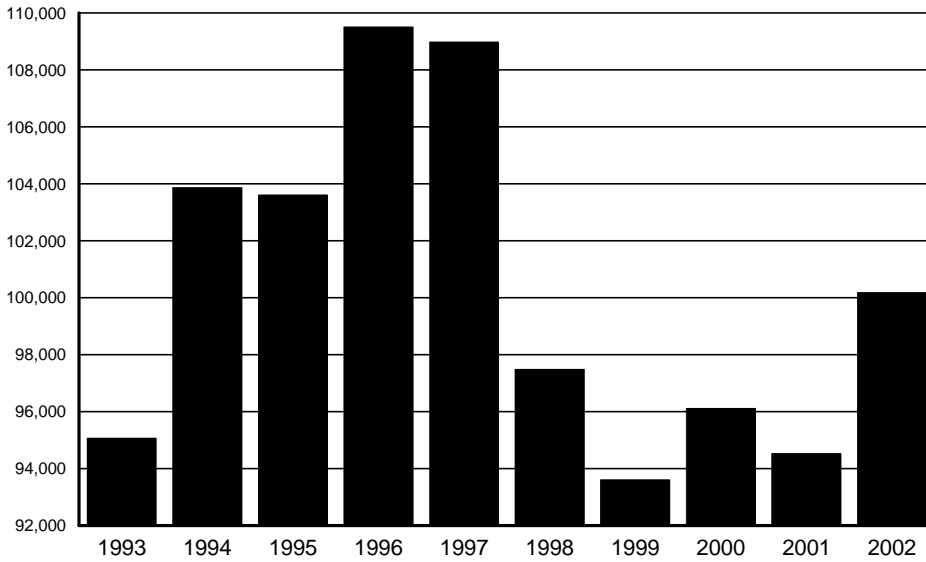

YEAR	TOTAL
1993	95,066
1994	103,861
1995	103,612
1996	109,506
1997	108,975
1998	97,485
1999	93,608
2000	96,116
2001	94,527
2002	100,185

In 1996, totals were the highest reported in a ten-year period, with the 2002 figure showing an 8.5% decrease from 1996.

MOTOR VEHICLE

YEAR	TOTAL
1993	15,526
1994	15,447
1995	16,262
1996	15,939
1997	14,640
1998	13,548
1999	12,129
2000	12,348
2001	12,568
2002	12,772

The number of vehicles stolen was at its lowest in 1999. There was a decrease of 21.5% from the highest figure in 1995 to 2002.

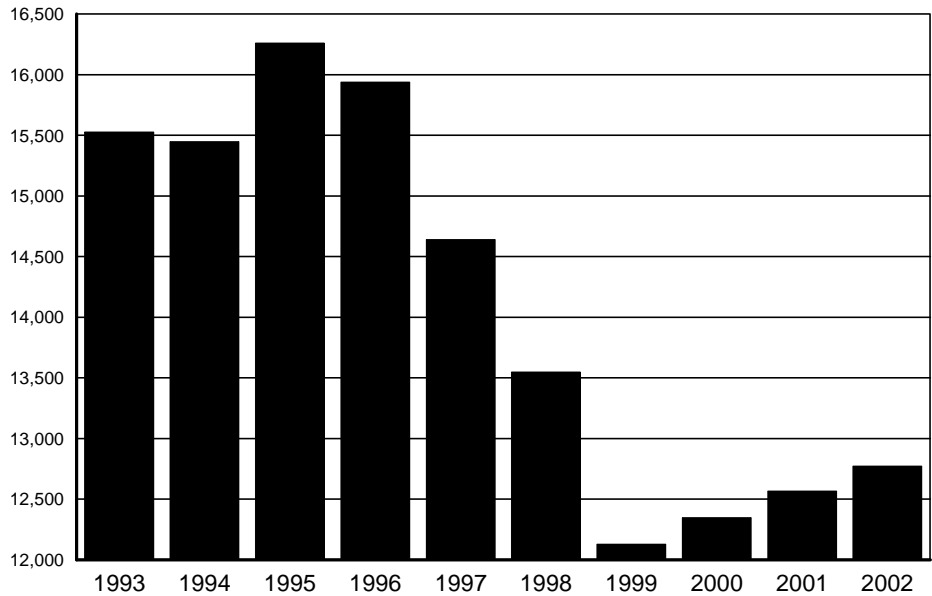

OKLAHOMA STATE BUREAU OF INVESTIGATION

ARSON

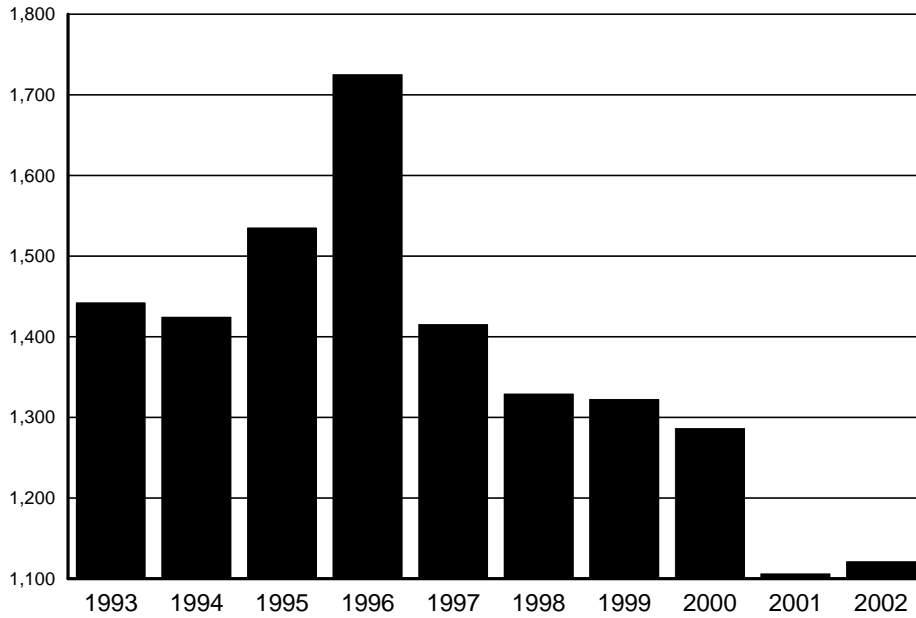

YEAR	TOTAL
1993	1,442
1994	1,424
1995	1,535
1996	1,725
1997	1,415
1998	1,329
1999	1,322
2000	1,286
2001	1,106
2002	1,121

Of the past ten years, 1996 ranked highest in the number of actual offenses.

VALUE OF PROPERTY STOLEN - RECOVERED

YEAR	VALUE STOLEN	VALUE RECOVERED
1993	140,789,158	45,218,907
1994	145,836,188	46,875,169
1995	163,222,335	55,727,273
1996	164,565,956	50,647,159
1997	165,804,963	45,764,096
1998	157,235,657	44,881,824
1999	147,350,446	41,574,010
2000	150,185,171	41,007,671
2001	161,787,155	42,231,529
2002	166,413,095	39,884,188

The value of property stolen was at its highest in 2002, with the highest volume of recovery in 1995.

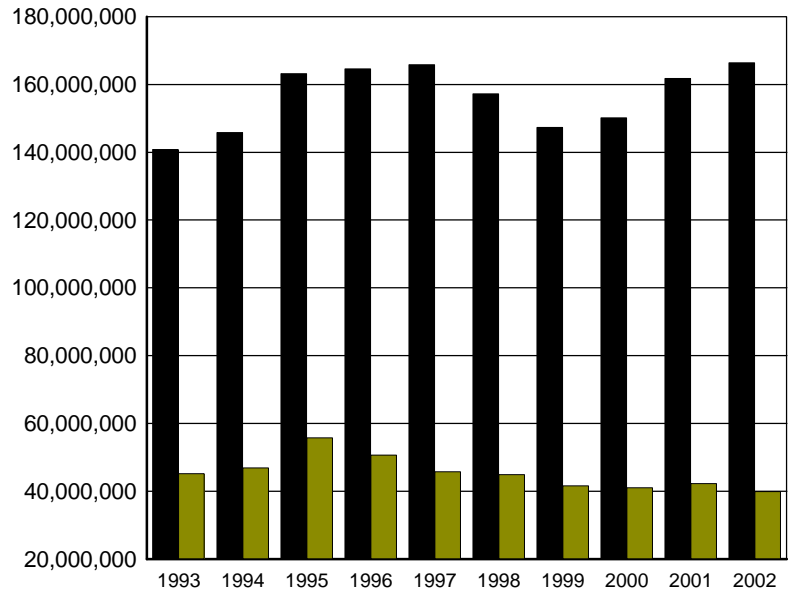

STOLEN

RECOVERED

II

UNIFORM CRIME
REPORTING
PROGRAM

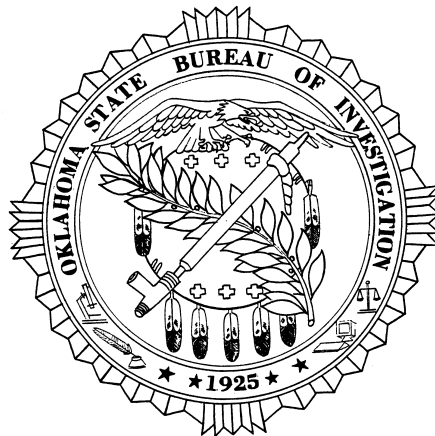

LEGISLATIVE MANDATE

The Annual Report "*Crime In Oklahoma*" presents criminal justice information in terms of offenses known to the police and criminal arrest activity in accordance with guidelines and regulations prescribed by law.

The Oklahoma Legislature, in establishing the Uniform Crime Reporting (UCR) statute, mandated the responsibility and authority for UCR data collection and dissemination to the Oklahoma State Bureau of Investigation. Guidelines established for the operation of the state's UCR Program are listed below:

SECTION 1. A Uniform Crime Reporting system shall be established under the direction, control, and supervision of the Director of the Oklahoma State Bureau of Investigation. The Director shall have the power and duty, by such rules and regulations as he may deem necessary, to collect and gather such information from such state, county, city, and town law enforcement agencies as may be and is hereinafter prescribed by law.

SECTION 2. The Oklahoma State Bureau of Investigation is hereby designated as the agency which shall collect, gather, assemble, and collate such information as is prescribed by law.

SECTION 3. All state, county, city, and town law enforcement agencies shall submit a monthly report to the Oklahoma State Bureau of Investigation on forms prescribed by the Bureau; which report shall contain the number and nature of offenses committed within their respective jurisdictions, the disposition of such matters and such other information as the Bureau may require, respecting information relating to the cause and prevention of crime, recidivism, the rehabilitation of criminals and the proper administration of criminal justice.

SECTION 4. Upon receipt of such information the Director shall have such data collated and formulated and shall compile such statistics as he may deem necessary in order to present a proper classification and analysis of the volume and nature of crime and the administration of criminal justice within this state.

OBJECTIVES

The fundamental objectives of the Oklahoma UCR Program are:

- (1) Inform the governor, legislature, and other governmental officials, and the public as to the nature of the crime problem in Oklahoma, its magnitude and its trends.
- (2) Provide law enforcement administrators with criminal statistics for administrative and operational use.
- (3) Determine who commits crimes by age, sex, and race in order to find the proper focus for crime prevention and enforcement.
- (4) Provide base data and statistics to measure the workload and effectiveness of Oklahoma's criminal justice system.
- (5) Provide base data and statistics to measure the effects of prevention and deterrence programs.
- (6) Provide base data and statistics for research to improve the efficiency, effectiveness, and performance of criminal justice agencies.
- (7) Provide data to assist in the assessment of social and other causes of crime for the development of theories on criminal behavior.
- (8) Provide the FBI with complete UCR data to be included in the national publication "*Crime in the United States.*"

REPORTING AND COLLECTION PROCEDURES

Under the Oklahoma UCR statute, all state, county, city, and town law enforcement agencies are required to submit crime reports.

The Field Services Unit, in an effort to maintain quality and uniformity in the data received, furnishes field representatives, who provide training in Uniform Crime Reporting procedures. Because a centralized records system is necessary to the sound operation of any law enforcement agency and is an essential basis for crime reporting by the agency, the Field Services Unit provides technical assistance to any law enforcement agency in the establishment or maintenance of a police records system.

On a monthly basis, law enforcement agencies report the number of offenses that become known to them during the month in the following categories: murder, manslaughter, forcible

rape, robbery, assault, burglary, larceny, and motor vehicle theft. This count is taken from a record of all complaints of crime received by the law enforcement agencies during their own operation.

Whenever complaints of crime are determined through investigation to be unfounded or false, they are eliminated from the actual count. The number of "actual offenses known" in these crime categories is reported without regard to (1) whether anyone is arrested for the crime; (2) the stolen property is recovered; (3) the local prosecution policy; (4) any other restrictive considerations. On a monthly basis, law enforcement agencies report the total number of reported crimes which they clear, either by arrest or exceptional means (a crime solution or clearance recorded when some element beyond law enforcement control precludes the placing of formal charges against the offender.) A separate count of crimes cleared which involve only persons under the age of 18 is shown. To supplement the offense information, such data as the value of property stolen and recovered, circumstances surrounding homicides, additional information concerning assaults on police officers, and other pertinent information is collected.

In addition, monthly reports for all persons arrested on all criminal offenses are collected. These reports provide age, sex, race, and ethnic origin information on each person arrested, with the adult and juvenile arrests reported separately.

As required by legislative mandate, the UCR offenses reported are also utilized to identify domestic abuse and hate/bias motivation crimes.

Law enforcement employees' data specifically encompasses the number of sworn and civilian personnel and is collected annually.

VERIFICATION

A primary consideration in the collection of criminal statistics in the State of Oklahoma is the uniformity and accuracy of the data. The Oklahoma UCR Guide Manual and personal instruction by field representatives do not necessarily guarantee the accuracy of the reports submitted by the contributors.

Each report received is recorded, examined and verified for mathematical accuracy and, more importantly, for reasonability. The validity and possibility of duplication are checked numerous times to avoid misinformation.

Minor errors are corrected by telephone between the field representative and the reporting agency, while substantial variations are adjusted through personal visits. The personal contacts are invaluable to the accuracy and quality of reporting. Field representatives are engaged in constant educational efforts, such as providing a vital training link between the UCR Program and the contributor.

USES OF CRIMINAL JUSTICE DATA

Throughout history, crime has generally been perceived as a serious social problem. Criminal behavior is one of the major domestic concerns in our nation today, and our citizens have the right to be informed of the full nature, magnitude, and trend of the crime problem. Moreover, it is impossible to assess the real costs of crime in our society without such disclosure. Ultimately, the public pays the costs of criminality. Their behavior patterns are altered by their fear of attack; they suffer the consequences of physical assault and have their possessions stolen or damaged. They pay higher insurance rates because of offenses against their property and increased costs for goods and services due to business losses from organized or unorganized crime. The public has a right to know the full extent of these costs. They support the institutions of our criminal justice system with the taxes they pay and, as citizens in a democracy, they have the right and the obligation to appraise the allocation and effectiveness of limited governmental resources. Both individual cooperation and collective citizen action are required for crime reduction and the improvement of our criminal justice system. But cooperation and action will not be forthcoming unless and until citizens receive a more complete disclosure of the true nature of crime and criminal justice.

Effective solutions to the crime problem will depend on increased research to determine and assess the cause of crime and to develop and test theories of criminal behavior. All of these efforts require comprehensive and valid criminal statistics. Social scientists and professional criminologists require quantified data that will indicate who commits what type of crime in order to establish typical "profiles" of criminals. Such profiles can help determine the proper focus and direction of crime prevention programs.

Administrators at every level of the criminal justice process require information with which to measure their workloads, identify and solve operational problems, and evaluate effectiveness. The lack of valid and complete statistics is critical when the needs of these managers are considered. Data is required for program planning, development, budgeting, and evaluating; for estimating resource requirements and for allocating manpower and equipment. Information is also required to develop comparative norms of performance, for cost effectiveness studies and for establishing data bases with which to analyze the criminal justice system at the local level.

The usefulness of Uniform Crime Reporting is extensive for law enforcement agencies. Information provided by the report can be applied to areas of statistics and hard data, as well as to aspects of planning and research.

CLASSIFICATION OF UCR OFFENSES

Offense data consists of information extracted from reports of Part I offenses that have been submitted by law enforcement agencies in the State of Oklahoma.

PART I OFFENSE DEFINITIONS ARE AS FOLLOWS:

- 1a. Murder—The willful killing of a human being.
- 1b. Manslaughter—The killing of a human being by the negligence of another.
2. Forcible Rape—The carnal knowledge of a female forcibly and against her will, including attempts.
3. Robbery—The forcible taking of the property of another against his/her will by violence and fear, including attempts.
4. Aggravated Assault—An offer or attempt with unlawful force or violence to do physical injury to another.
5. Burglary (Breaking and Entering) - An unlawful or forcible entry of any structure to commit a felony or larceny, including attempts.
6. Larceny (Theft) - The unlawful taking of property with intent to deprive another of ownership.
7. Auto or Other Motor Vehicle Theft—The larceny or attempted larceny of a motor vehicle.
8. Arson—Willful or malicious burning with or without intent to defraud, including attempts.

All other crimes that are not classified as Part I offenses make up the Part II offenses. Information on these are only reported when an arrest has been made.

PART II OFFENSE DEFINITIONS ARE AS FOLLOWS:

9. Other Assaults (not aggravated) - Assaults and attempted assaults which are simple and minor in nature.
10. Forgery and Counterfeiting—Making, altering, uttering, or possessing, or attempts to make, alter, or possess with intent to defraud. Anything which is made to appear true.
11. Fraud - Fraudulent conversion of another's money or property by false pretenses.

12. Embezzlement—Misappropriation or misapplication of money or property entrusted to one's care, custody, or control.
13. Stolen Property - All offenses of buying, receiving, and possessing stolen property, as well as all attempts to commit any of these offenses.
14. Vandalism - Willful or malicious destruction, injury, disfigurement, or defacement of property without consent of the owner or persons having custody or control.
15. Weapons-Carrying, Possessing, etc. - All violations of regulations or statutes controlling the carrying, using, possessing, furnishing, and manufacturing of deadly weapons or silencers and all attempts to commit any of the offenses.
16. Prostitution and Commercialized Vice - Sex offenses of a commercialized nature, such as prostitution, keeping a bawdy house, procuring or transporting women for immoral purposes, and all attempts to commit any of these offenses.
17. Sex Offenses (except Forcible Rape, Prostitution, and Commercialized Vice) - Statutory rape, offenses against chastity, common decency, morals, and the like, including attempts.
18. Drug Abuse Violations - Includes all arrests for violations of state and local ordinances subdivided into the categories of possession and sale/manufacturing of narcotic drugs.
19. Gambling - Promoting, permitting, or engaging in gambling.
20. Offenses Against Family and Children - Nonsupport, neglect, desertion, or abuse of family and children.
21. Driving Under the Influence - Driving or operating any motor vehicle while drunk or under the influence of liquor or drugs.
22. Liquor Laws - State or local liquor law violations, except "drunkenness" and "driving under the influence."
23. Drunkenness - Drunk and disorderly.
24. Disorderly Conduct - Breach of peace (disorderly person.)
25. Vagrancy - Not reported in Oklahoma.
26. All Other Offenses - All other violations of state and local laws.
27. Suspicion - Not reported in Oklahoma.

28. Curfew and Loitering Laws - Applicable only to juveniles.
29. Runaway - Applicable only to juveniles.

III
INDEX
CRIME

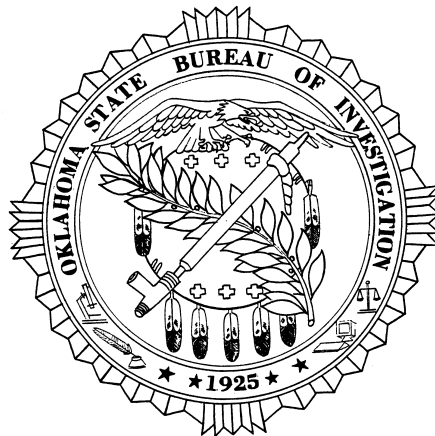

OKLAHOMA STATE BUREAU OF INVESTIGATION

INDEX CRIME OFFENSES

The following three graphs illustrate the variations of the 2000, 2001, and 2002 total number of offenses by month. This information is based on the Oklahoma Crime Index.

The first graph represents the total number of index crime offenses occurring each month. The other two take the analysis further with breakdowns of violent crimes and non-violent crimes by month.

SUMMARY ANALYSIS

A total of 165,715 index crimes was reported in 2002. With 15,723 offenses, the month of July reflected the highest number of index crimes reported. The month of February showed the lowest number of reported offenses with 10,826 index crimes.

A further breakdown of the 2002 index crime offenses shows August had the greatest number of violent crimes with 1,827 offenses reported. The lowest number of violent crimes occurred in February with 1,178 offenses reported. A monthly analysis of the non-violent crimes indicates that July and February showed the highest and lowest number of offenses with monthly totals of 14,051 and 9,648 respectively.

INDEX CRIME OFFENSES

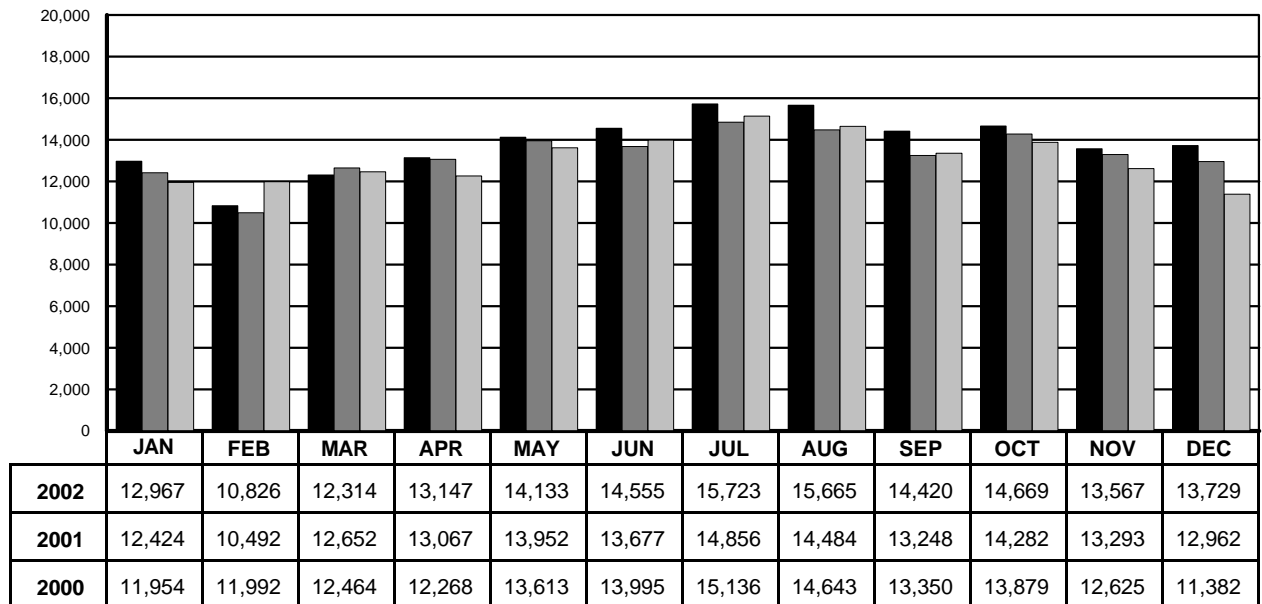

2002
 2001
 2000

OKLAHOMA STATE BUREAU OF INVESTIGATION

VIOLENT CRIME BY MONTH

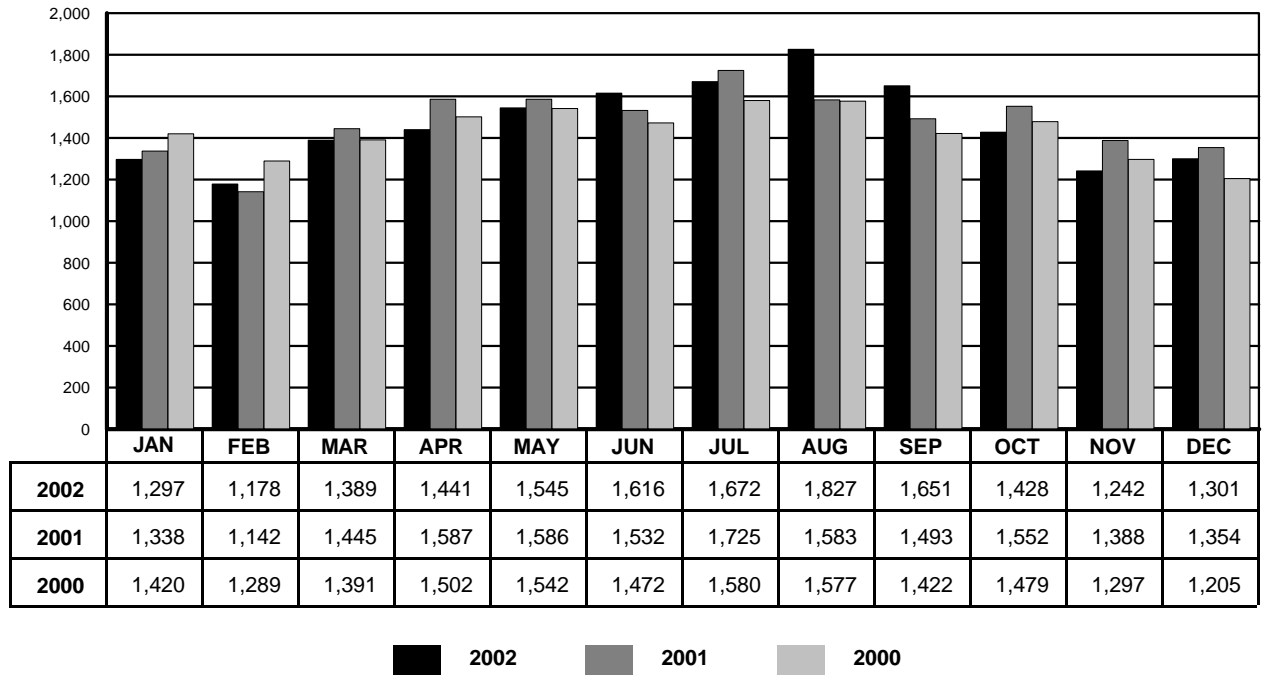

NON-VIOLENT CRIME BY MONTH

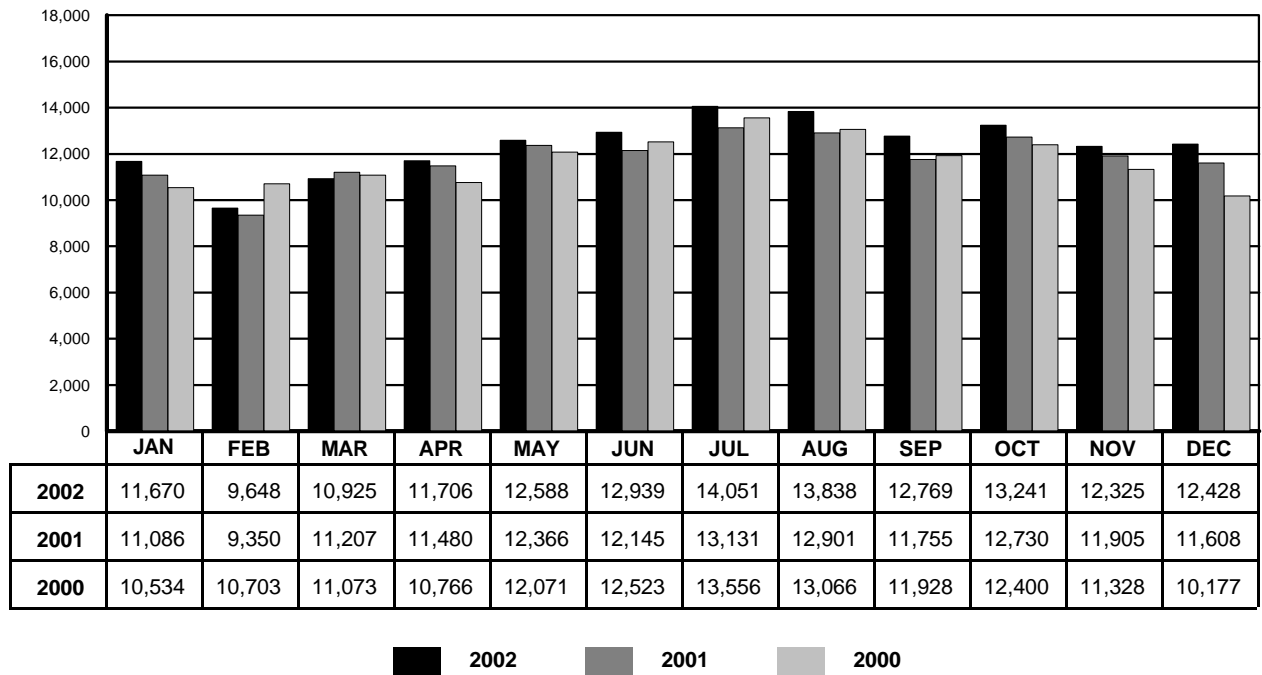

OKLAHOMA STATE BUREAU OF INVESTIGATION

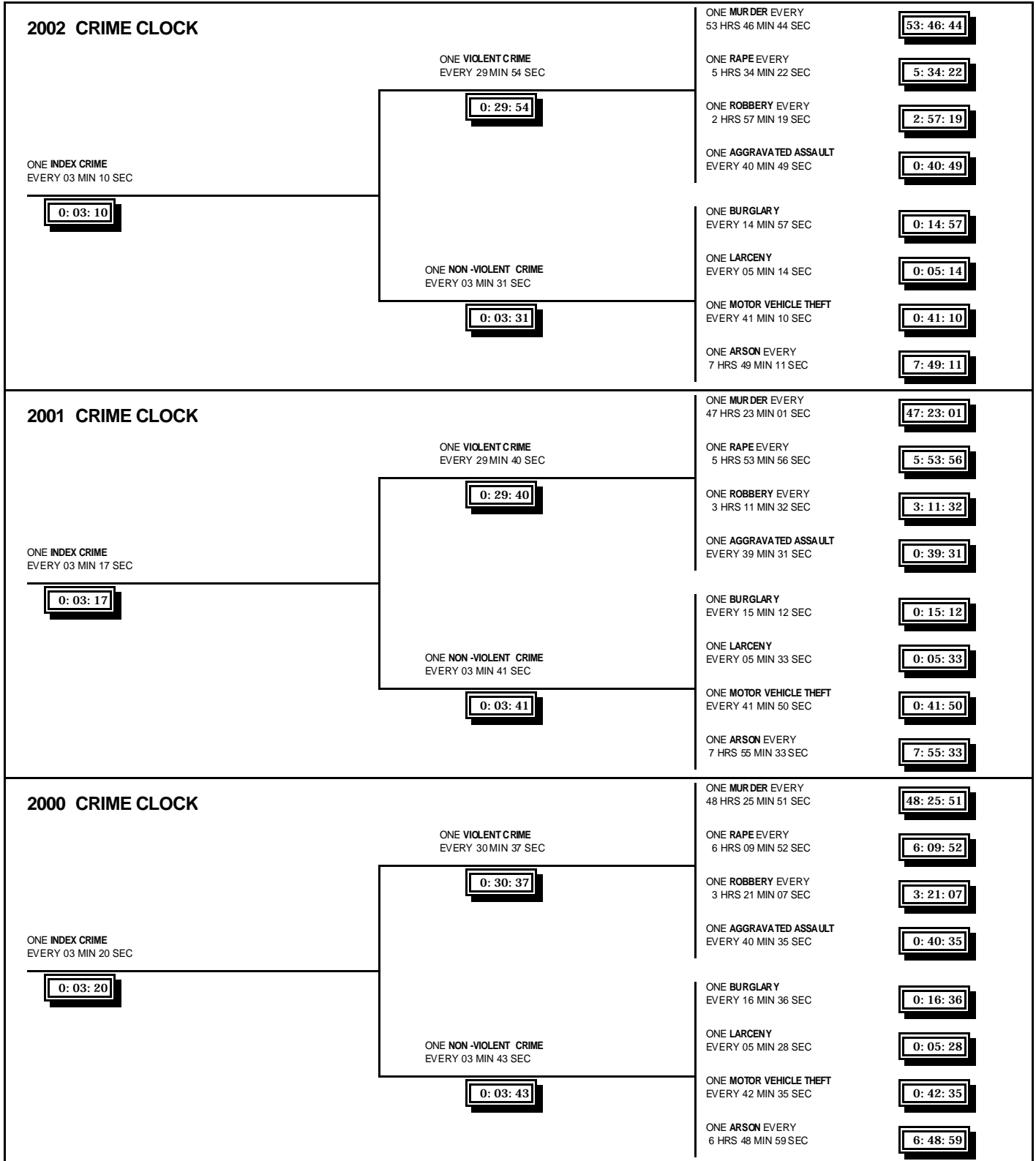

This crime clock should be viewed with care. Being the most aggregate representation of UCR data, it is designed to convey the annual reported crime experience by showing the relative frequency of occurrence of the Index Offenses. This mode of display should not be taken to imply a regularity in the commission of Part I Offenses; rather, it represents the annual ratio of crime to fixed time intervals.

OKLAHOMA STATE BUREAU OF INVESTIGATION

MURDER

Definition: The unlawful killing of a human being in which the element of malice aforethought was present.

Any death due to a fight, argument, quarrel, assault, or commission of a crime is included. This index offense, as in all other crime index offenses, is scored by law enforcement officials on the basis of their investigation and does not include the findings of a court or the decision of a prosecutor. Manslaughters, suicides, accidental deaths, and justifiable homicides are excluded from this category. Attempts to kill and assaults to kill are scored as assaults and not as murder.

SUMMARY ANALYSIS

A total of 163 murders was reported by law enforcement agencies in 2002.

Murders accounted for 0.9% of all violent crimes and 0.1% of all index crimes reported.

A total of 157 murders was cleared by arrest or exceptional means, representing a clearance rate of 96.3%.

The 30-year-old to 34-year-old age group accounted for the highest percentage of persons arrested for murder at approximately 11.5% of the total. Of the 174 persons arrested for murder, 62.6% were White, 30.5% were Black, 6.3% were Indian, and 0.6% were Asian.

Firearms were employed in 52.8% of all reported murders. The use of a knife or other cutting device was involved in 22.7% of the murders.

The murder of one family member by another accounted for 33 offenses or 20.2% of all murders; 9.2% of the 163 offenses resulted from one spouse killing the other.

The victim-offender relationship was identified in 137 of the 163 reported murders. In 83.9% of these cases, the victims were known by the offenders.

The value of property stolen in actual offenses of murder totaled \$132,620 for 2002.

OKLAHOMA STATE BUREAU OF INVESTIGATION

MURDER BY MONTH

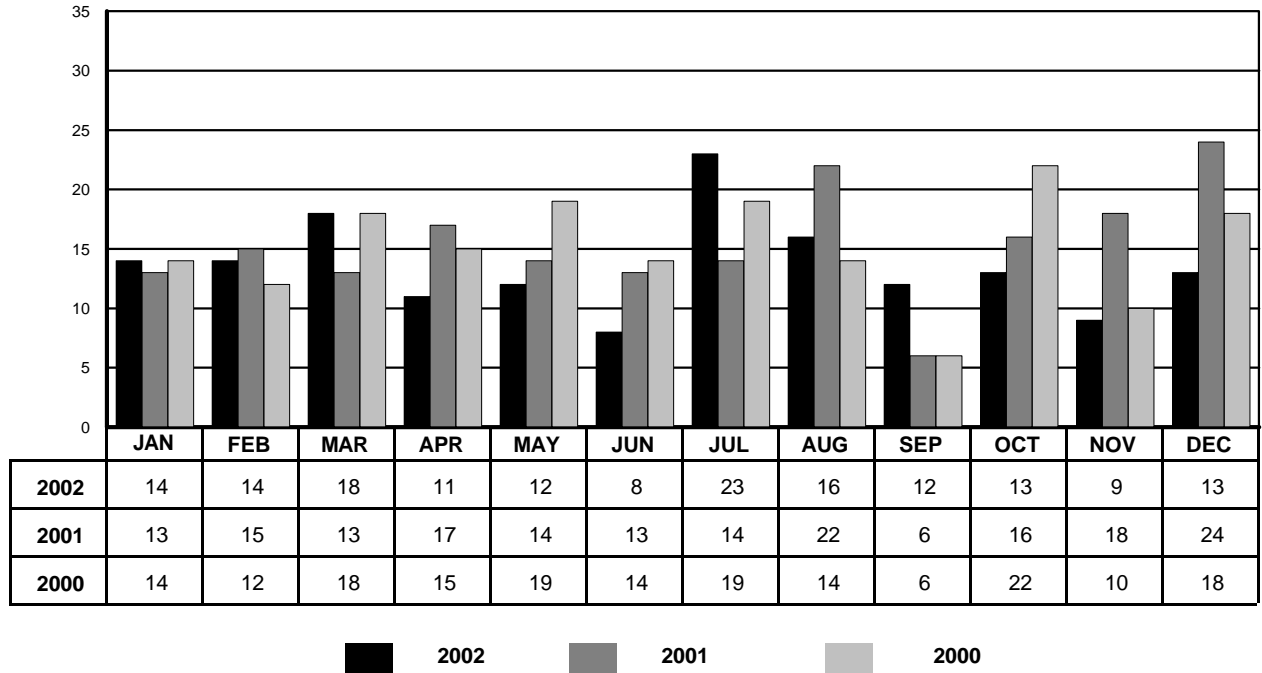

MURDER BY DAY OF WEEK

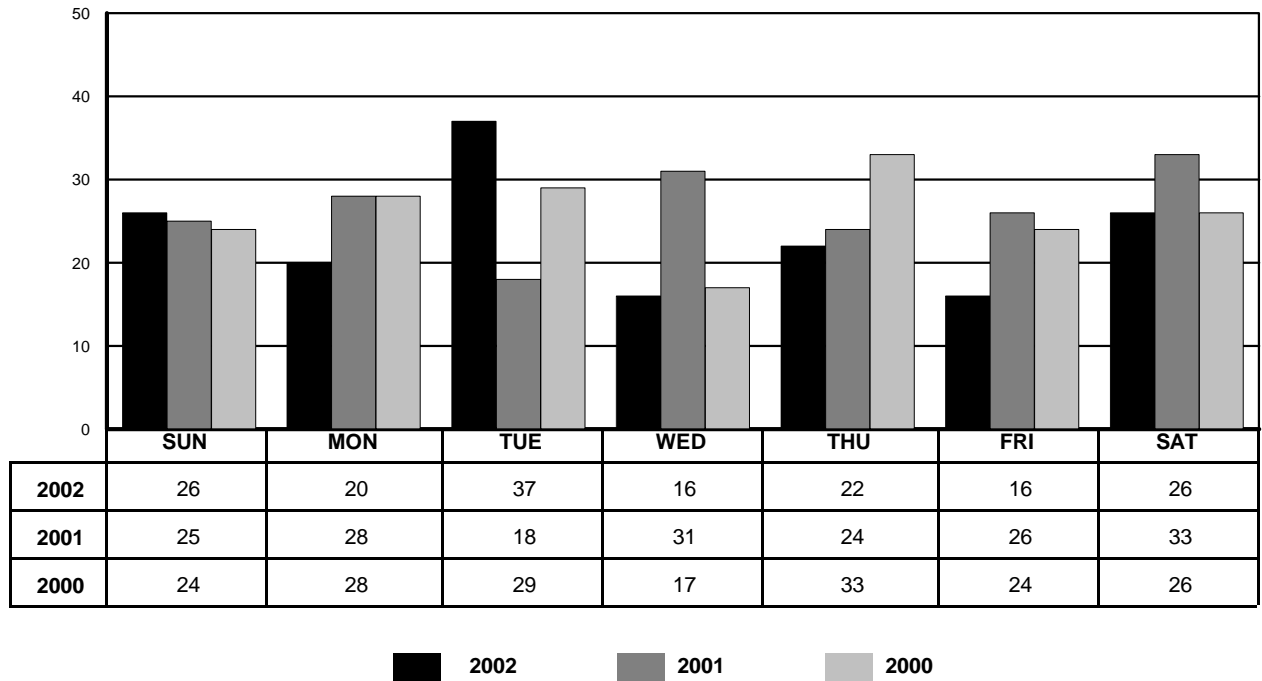

OKLAHOMA STATE BUREAU OF INVESTIGATION

MURDER BY AGE, SEX, AND RACE

As illustrated in the following table, 68.1% of the murder victims were male and 31.9% were female. Approximately 69.9% of all victims were White, 19.0% were Black, 9.2% were Indian, and 1.8% were Asian. The age range of 20 to 29 years accounted for the largest number of murder victims in any ten-year age bracket.

AGE	NUMBER			PERCENT DISTRIBUTION		
	2002	2001	2000	2002	2001	2000
1 & UNDER	10	6	9	6.1	3.2	5.0
2 - 5	3	2	2	1.8	1.1	1.1
6 - 10	1	4	1	0.6	2.2	0.6
11 - 14	0	2	2	0.0	1.1	1.1
15 - 19	13	21	12	8.0	11.4	6.6
20 - 24	25	27	29	15.3	14.6	16.0
25 - 29	19	20	25	11.7	10.8	13.8
30 - 34	15	21	17	9.2	11.4	9.4
35 - 39	16	18	17	9.8	9.7	9.4
40 - 44	16	19	22	9.8	10.3	12.2
45 - 49	9	10	11	5.5	5.4	6.1
50 - 54	10	9	7	6.1	4.9	3.9
55 - 59	10	6	10	6.1	3.2	5.5
60 - 64	5	8	5	3.1	4.3	2.8
65 - 69	6	1	2	3.7	0.5	1.1
70 - 74	3	5	3	1.8	2.7	1.7
75 & OVER	2	6	7	1.2	3.2	3.9
UNKNOWN	0	0	0	0.0	0.0	0.0
TOTAL	163	185	181	100.0	100.0	100.0
SEX						
MALE	111	127	128	68.1	68.6	70.7
FEMALE	52	58	53	31.9	31.4	29.3
UNKNOWN	0	0	0	0.0	0.0	0.0
TOTAL	163	185	181	100.0	100.0	100.0
RACE						
WHITE	114	118	122	69.9	63.8	67.4
BLACK	31	54	46	19.0	29.2	25.4
INDIAN	15	13	12	9.2	7.0	6.6
ASIAN	3	0	1	1.8	0.0	0.6
UNKNOWN	0	0	0	0.0	0.0	0.0
TOTAL	163	185	181	100.0	100.0	100.0
ETHNICITY						
NON - HISPANIC	148	171	168	90.8	92.4	92.8
HISPANIC	12	11	13	7.4	5.9	7.2
UNKNOWN	3	3	0	1.8	1.6	0.0
TOTAL	163	185	181	100.0	100.0	100.0

OKLAHOMA STATE BUREAU OF INVESTIGATION

MURDER BY OFFENSE - 2002

FELONY TYPE		OTHER THAN FELONY	
OFFENSE	NUMBER	OFFENSE	NUMBER
Robbery	19	Lover's Triangle	7
Larceny	1	Child Killed by Babysitter	5
Motor Vehicle Theft	1	Brawl Due to Influence of Alcohol	14
Arson	1	Brawl Due to Influence of Narcotics	9
Prostitution and Commercialized Vice	1	Argument Over Money or Property	4
Narcotic Drug Laws	2	Other Arguments	52
Other - not specified	7	Other	20
All Suspected Felony Types	8	Unknown Circumstances	12
TOTAL FELONY RELATED	40	TOTAL NON - FELONY RELATED	123

MURDER BY RELATIONSHIP

FAMILY		OTHER THAN FAMILY	
RELATIONSHIP (VICTIM TO OFFENDER)	NUMBER	RELATIONSHIP (VICTIM TO OFFENDER)	NUMBER
Brother	1	Acquaintance	66
Common-Law Husband	1	Boyfriend	2
Common-Law Wife	3	Friend	3
Daughter	6	Girlfriend	6
Father	1	Homosexual Relationship	1
Husband	6	Neighbor	2
Mother	2	Other - Known to Victim	1
Other Family	3	Stranger	22
Stepfather	1	Relationship Not Determined	26
Sister	0	Ex-Wife	1
Son	2		
Stepson	2		
Wife	5		
TOTAL FAMILY	33	TOTAL NON - FAMILY	130

MURDER BY WEAPON

WEAPON	NUMBER	% DISTRIBUTION
Firearm, type not stated - does not include mechanic's grease gun or caulking gun	7	4.3
Handgun - pistol, revolver, etc.	54	33.1
Rifle	12	7.4
Shotgun	10	6.1
Other gun	3	1.8
Knife or Cutting Instrument - including ice pick, screwdriver, ax, etc.	37	22.7
Blunt Object - hammer, club etc.	11	6.7
Personal Weapons - includes beating by hands, feet and other body members	20	12.3
Fire/Arson	2	1.2
Strangulation/Hanging	1	0.6
Other - type not designated or known	6	3.7
TOTAL WEAPONS	163	100.0

OKLAHOMA STATE BUREAU OF INVESTIGATION

RAPE

Definition: The carnal knowledge of a female forcibly and against her will, regardless of age. Statutory rape is not included in this category.

Forcible rape differs from other violent crimes in that the victim, in many cases, is hesitant to report the offense to the police. The rigors of court proceedings and the embarrassment caused by the social stigma placed on this crime have a deterrent effect on the victim's willingness to make the crime known to the police.

For the purpose of Uniform Crime Reporting, rape is divided into two categories: (1) rape by force; (2) attempts to rape. Assaults to commit forcible rape are included in the index offenses category of rape.

SUMMARY ANALYSIS

A total of 1,573 forcible and attempted rapes was reported by law enforcement agencies in 2002.

Forcible rapes accounted for approximately 8.9% of all violent crimes and approximately 0.9% of all index crimes reported.

A total of 927 rapes was cleared by arrest or exceptional means, resulting in a clearance rate of 58.9%.

Of all persons arrested for rape, 47.4% were under the age of 25; 64.1% were White, 26.5% were Black, 8.5% were Indian, and 0.9% were Asian.

The value of property stolen in the actual offense of rape totaled \$25,653.

OKLAHOMA STATE BUREAU OF INVESTIGATION

RAPE BY MONTH

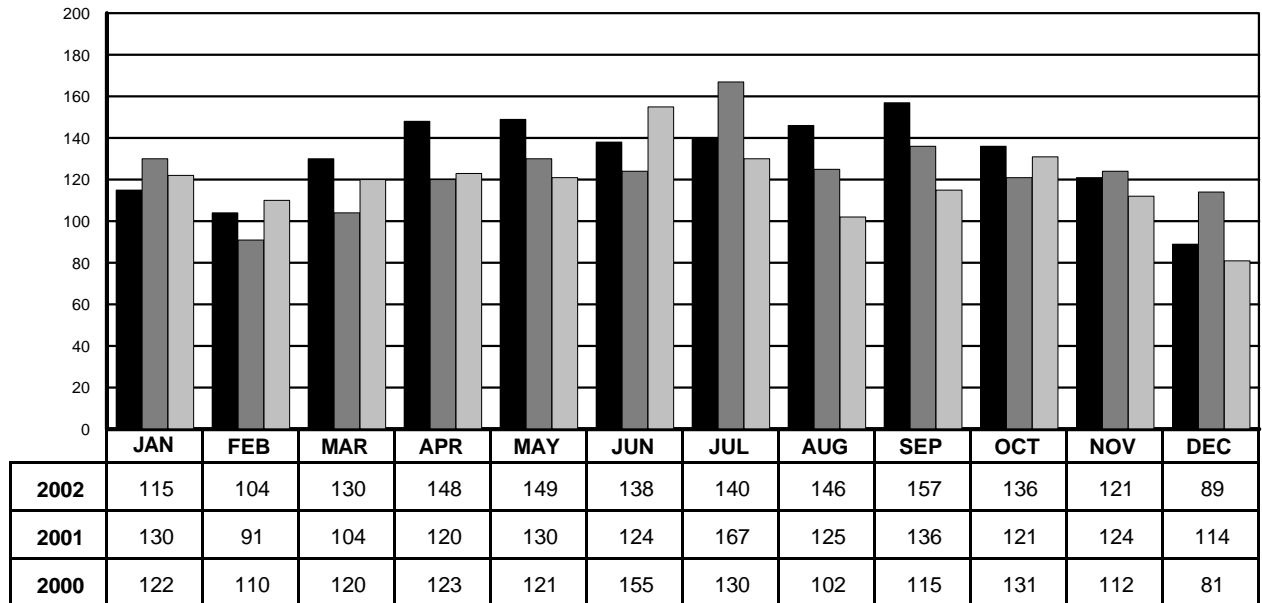

2002
 2001
 2000

RAPE - FORCIBLE AND ATTEMPTS

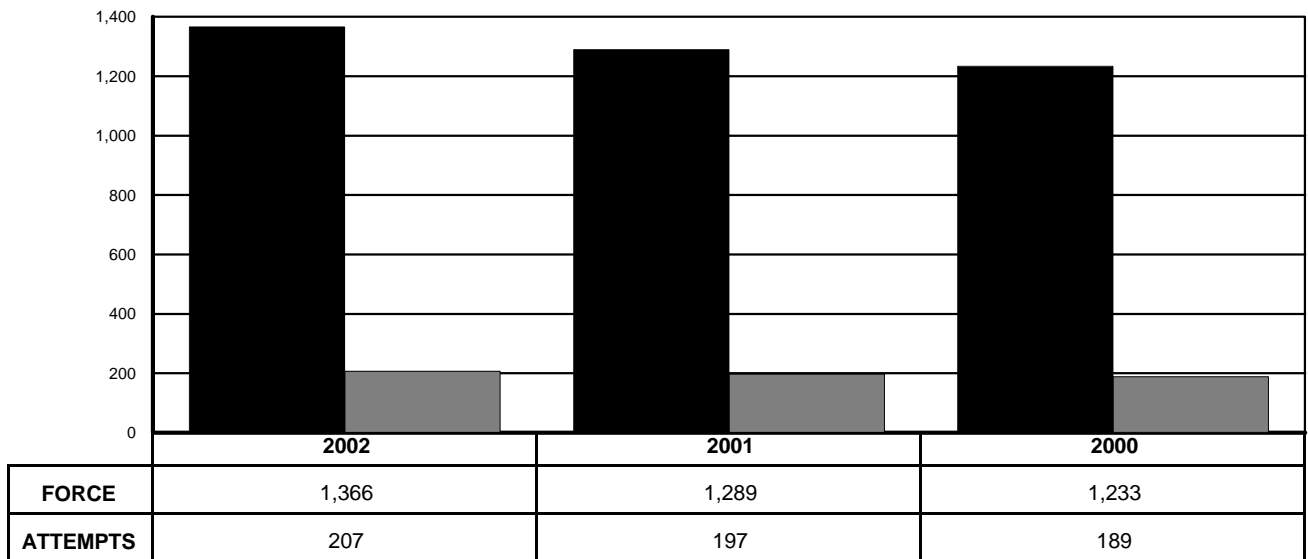

FORCE
 ATTEMPTS

OKLAHOMA STATE BUREAU OF INVESTIGATION

ROBBERY

Definition: The felonious and forcible taking of property from the care, custody, or control of a person or persons by violence or putting the person in fear and against his/her will.

In order for the crime of robbery to take place, the victim must be present. Robberies are reported in the following categories: gun, knife or cutting instrument, other dangerous weapon, and strong-arm robbery.

SUMMARY ANALYSIS

A total of 2,966 robberies was reported by law enforcement agencies in 2002.

Robberies accounted for 16.9% of all violent crimes and 1.8% of all index crimes reported. A total of 1,011 robberies was cleared; this was a clearance rate of 34.1%.

The highest percentage of persons arrested for robbery (11.5%) was in the 30-year-old to 34-year-old age category. Of all persons arrested for robbery, 41.8% were White, 53.4% were Black, 4.6% were Indian, and 0.3% were Asian.

The largest number of actual offenses of robbery (1,000) occurred in the miscellaneous robbery category, representing 33.7% of all reported robberies. Armed robbery (with any type of weapon) was responsible for 57.5% of the total number of offenses.

The value of property stolen in robberies totaled \$3,170,358 or 1.9% of the total value of property stolen during the year.

ROBBERY BY CLASSIFICATION

	2002		2001		2000	
	OFFENSES	VALUES	OFFENSES	VALUES	OFFENSES	VALUES
HIGHWAY	802	\$ 593,495	705	\$ 422,370	726	\$ 623,938
COMMERCIAL HOUSE	413	\$ 1,284,078	383	\$ 509,141	315	\$ 379,773
SERVICE STATION	40	\$ 7,665	44	\$ 41,916	51	\$ 18,235
CONVENIENCE STORE	244	\$ 146,014	269	\$ 112,968	260	\$ 119,999
RESIDENCE	428	\$ 422,728	427	\$ 516,286	438	\$ 474,906
BANK	39	\$ 236,045	48	\$ 169,351	31	\$ 117,249
MISCELLANEOUS	1,000	\$ 480,333	870	\$ 407,464	794	\$ 571,908
TOTAL	2,966	\$ 3,170,358	2,746	\$ 2,179,496	2,615	\$ 2,306,008

OKLAHOMA STATE BUREAU OF INVESTIGATION

ROBBERY BY MONTH

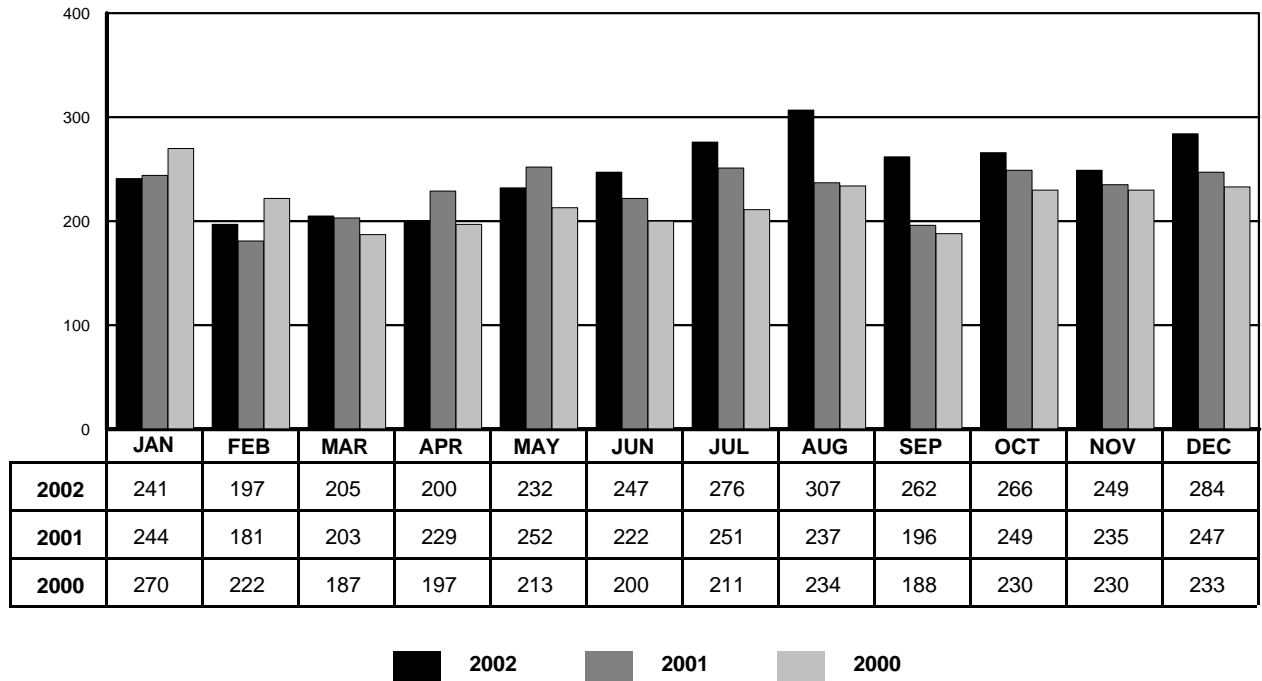

ROBBERY BY WEAPON

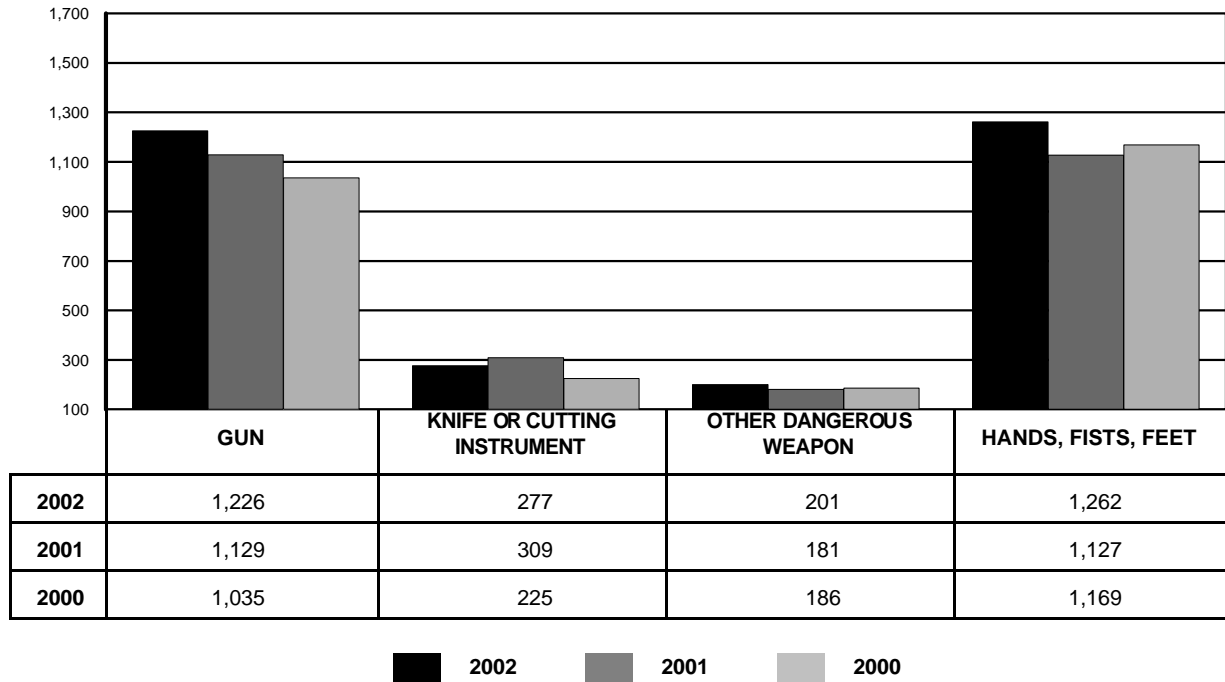

OKLAHOMA STATE BUREAU OF INVESTIGATION

AGGRAVATED ASSAULT

Definition: The unlawful attack or an attempt to attack through force or violence to do physical injury to another.

An aggravated assault may be committed with a gun, knife or other cutting instrument, other dangerous weapon, or through the aggravated use of hands, fists, or feet. All assaults, where no weapon is used and which result in minor injuries, are classified as non-aggravated and are not counted in the index crime totals.

SUMMARY ANALYSIS

A total of 12,885 aggravated assaults was reported by law enforcement agencies in 2002.

Aggravated assaults accounted for 73.3% of all violent crimes and 7.8% of all index crimes reported.

A total of 7,276 aggravated assaults was cleared by arrest or exceptional means, representing a clearance rate of 56.5%.

The 25-year-old to 29-year-old age group, at 13.4% accounted for the highest percentage of persons arrested for aggravated assault. Of all persons arrested, 66.1% were White, 23.4% were Black, 9.8% were Indian, and 0.7% were Asian.

Of all types of aggravated assaults, the use of "other dangerous weapon" was the most prevalent; this category reflected 4,802 offenses or 37.3% of all aggravated assaults.

OKLAHOMA STATE BUREAU OF INVESTIGATION

AGGRAVATED ASSAULT BY MONTH

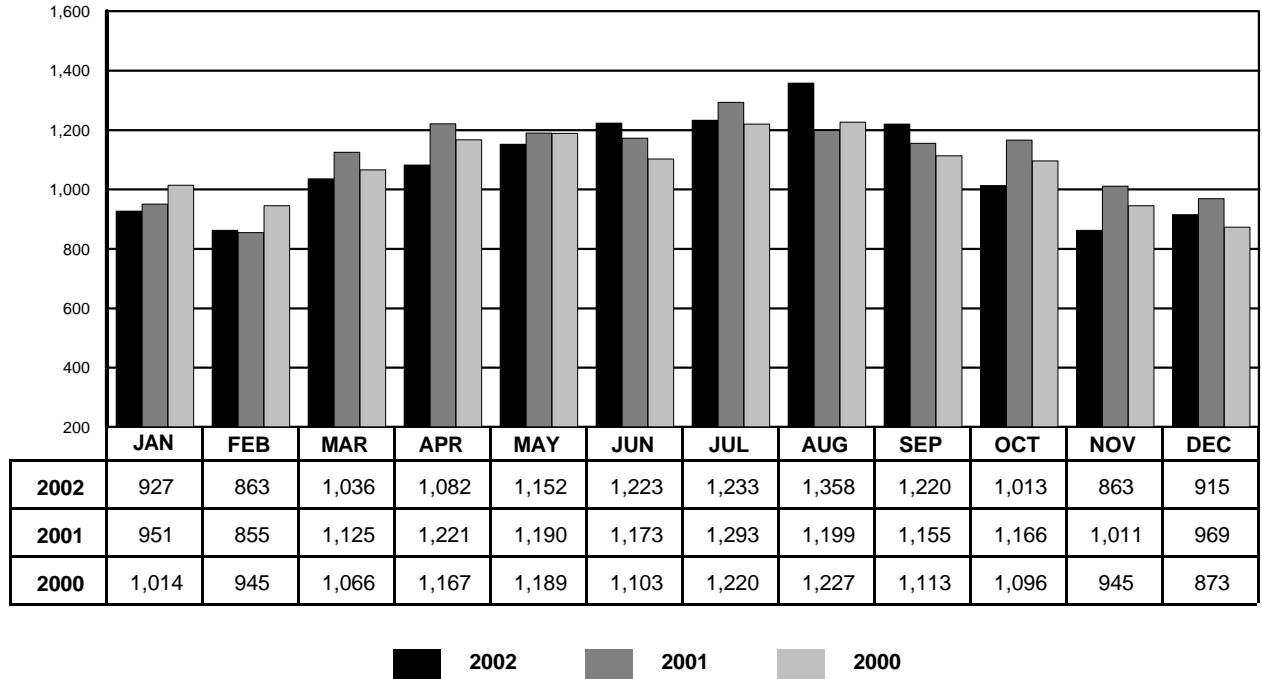

AGGRAVATED ASSAULT BY WEAPON

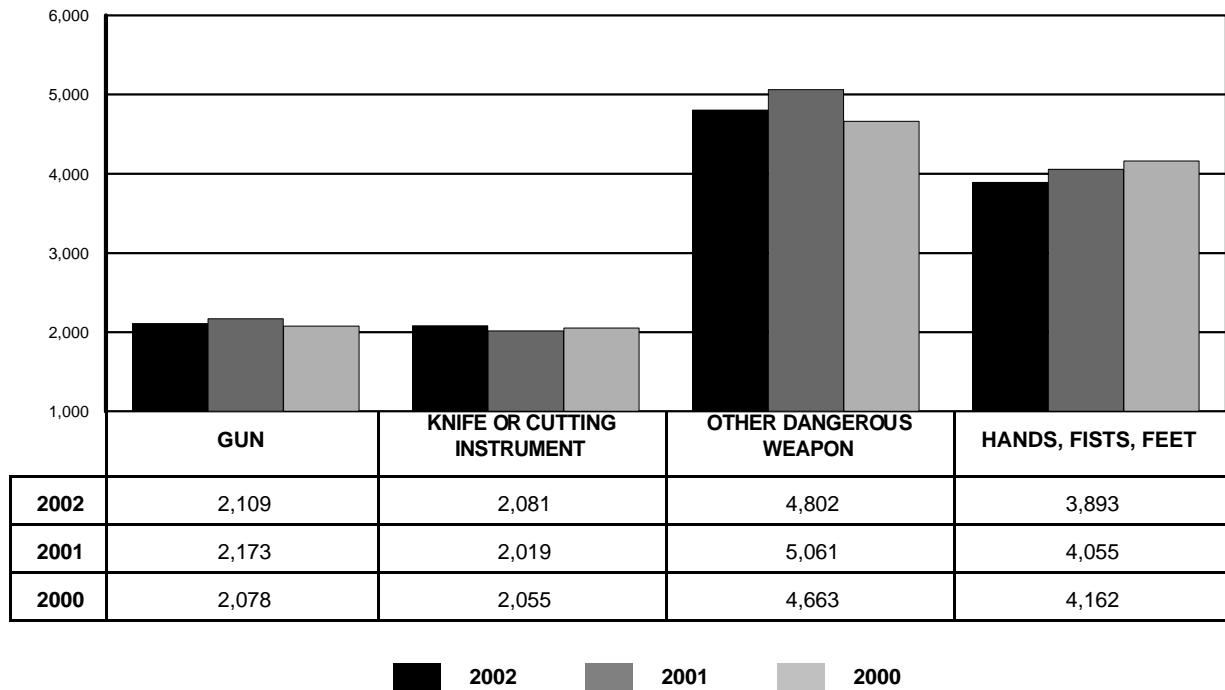

OKLAHOMA STATE BUREAU OF INVESTIGATION

BURGLARY

Definition: Any unlawful or attempted forcible entry of a structure to commit a felony or larceny, even though force may not have been used to gain entry.

For Uniform Crime Reporting purposes, the offense of burglary is divided into three categories: (1) forcible entry; (2) unlawful entry; (3) attempted forcible entry.

SUMMARY ANALYSIS

A total of 35,171 burglaries was reported in 2002.

Burglaries accounted for 23.7% of all non-violent crimes and 21.2% of all index crimes reported.

A total of 4,548 burglaries was cleared by arrest or exceptional means. This was a clearance rate of 12.9%.

The 25-year-old to 29-year-old age group accounted for the highest percentage of adults arrested for burglary at 13.6%. The 13-year-old to 14-year-old age accounted for the highest percentage of juvenile offenders arrested.

Persons under the age of 18 were accountable for 32.6% of all burglary arrests and 1.9% of burglaries cleared.

Of all persons arrested, 68.0% were White, 24.3% were Black, 7.2% were Indian, and 0.5% were Asian.

Forcible entry was the most prevalent of the three categories of burglary, with 25,422 actual offenses. This represents 72.3% of the total burglaries committed. Unlawful entry (no force) constituted 22.6%, while 5.1% were attempts.

The value of property stolen in actual offenses of burglary totaled \$47,012,510 or 28.3% of the total value of property stolen during 2002.

Residential burglaries accounted for 74.7% of the total offenses reported, with a total dollar loss of \$32,816,867. The number of residential burglaries was 26,289. Daytime hours accounted for 28.7% of all burglaries; 31.4% took place in the nighttime. The remainder occurred at undetermined times.

OKLAHOMA STATE BUREAU OF INVESTIGATION

BURGLARY BY MONTH

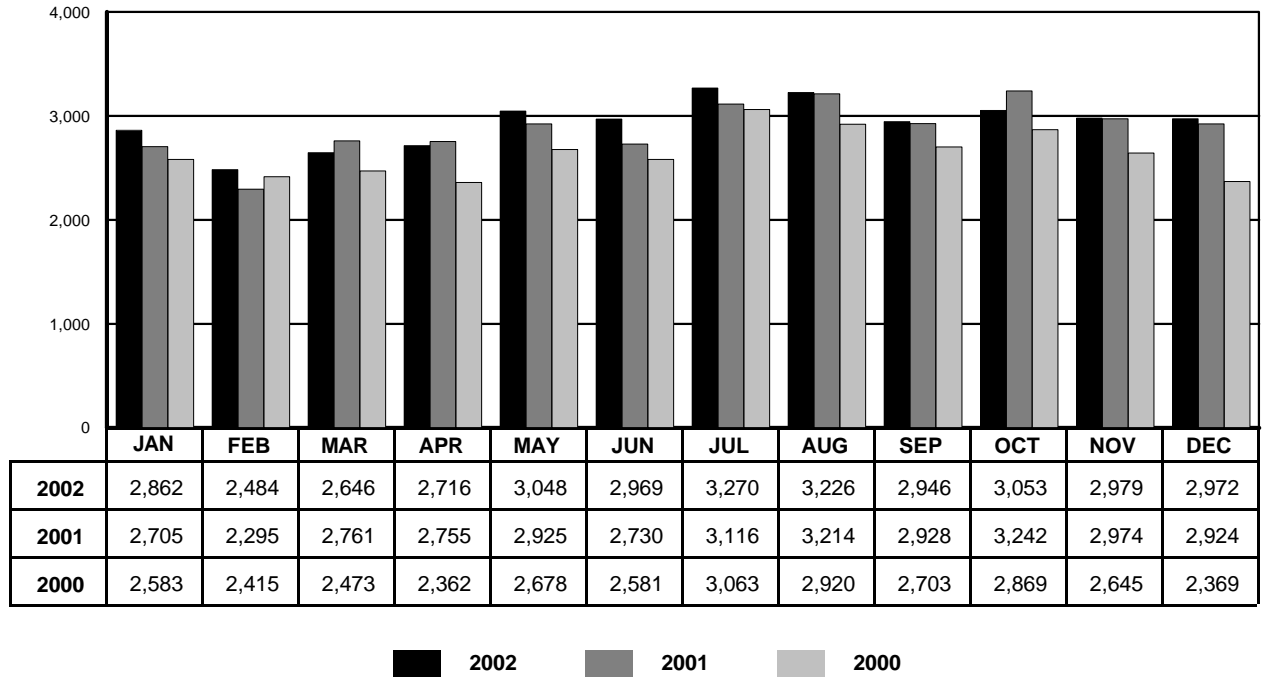

BURGLARY BY TYPE

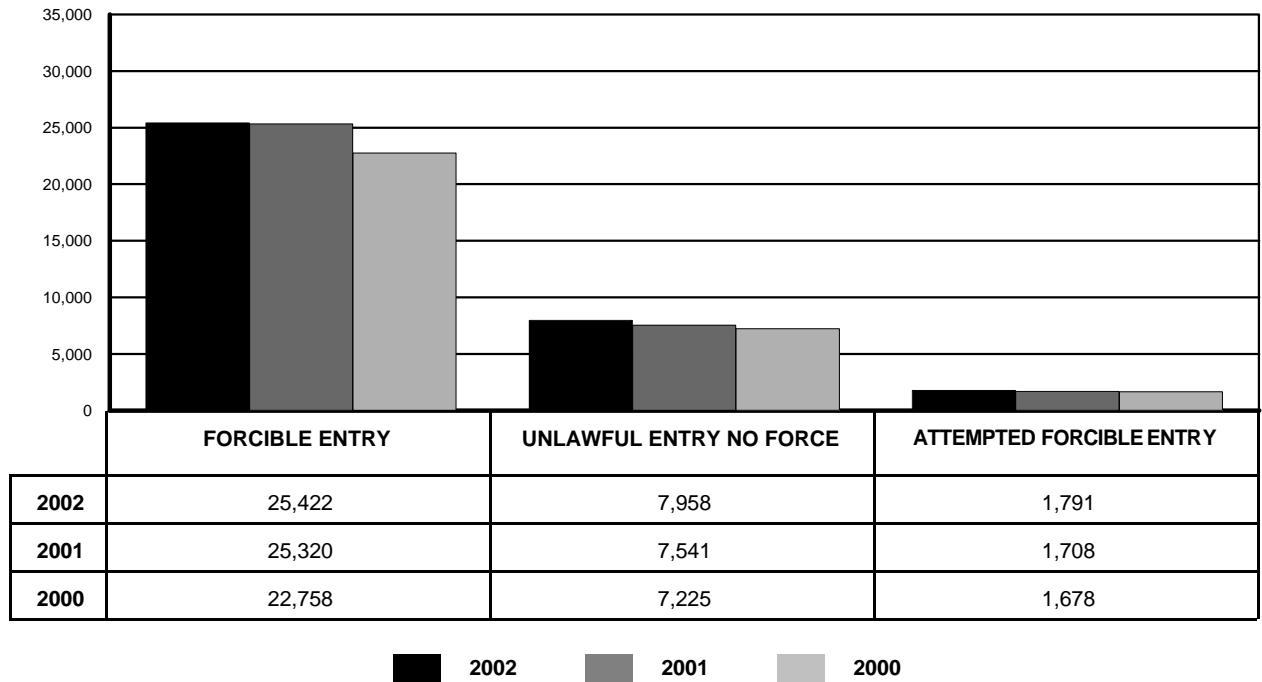

OKLAHOMA STATE BUREAU OF INVESTIGATION

BURGLARY - RESIDENCE

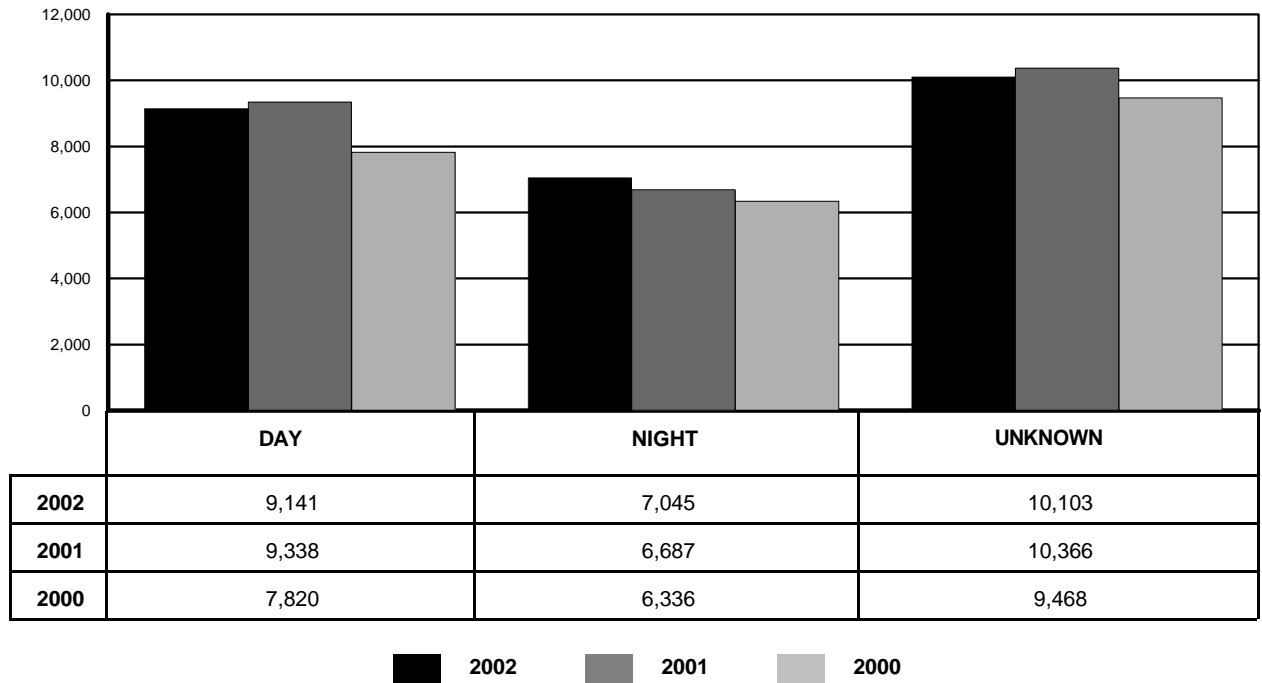

BURGLARY - NON-RESIDENCE

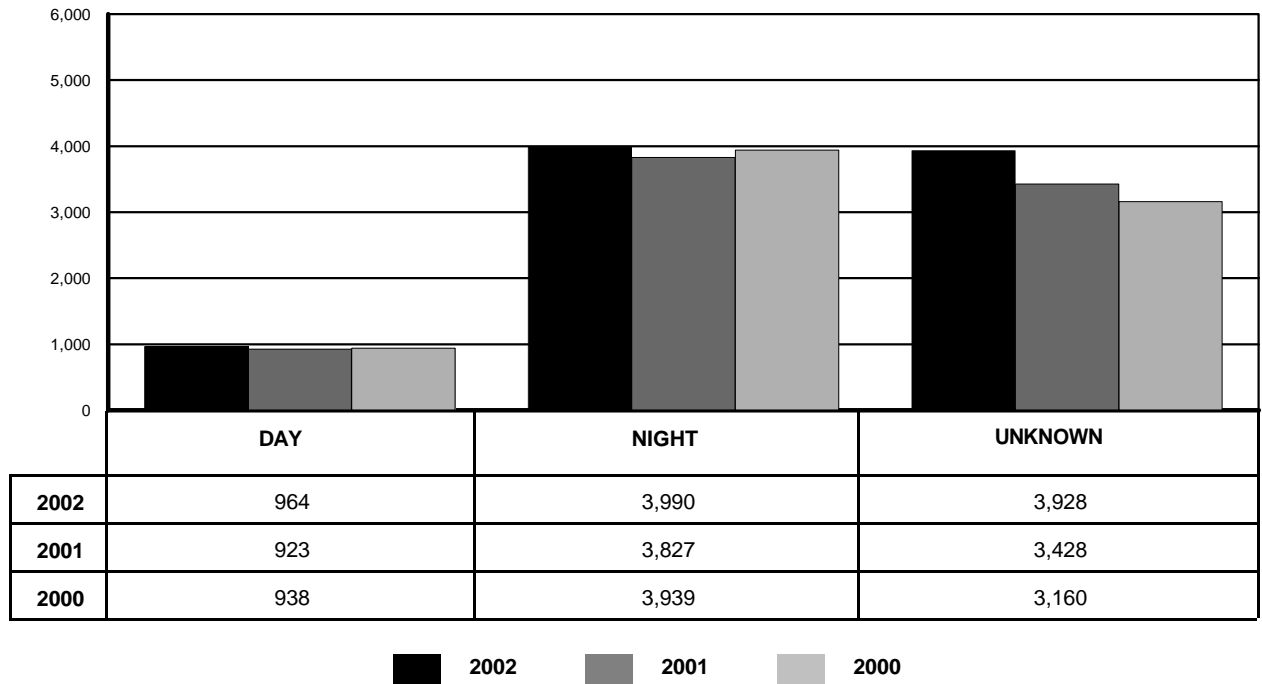

OKLAHOMA STATE BUREAU OF INVESTIGATION

BURGLARY BY CLASSIFICATION

CLASSIFICATION		YEAR	NUMBER OF OFFENSES	% CHANGE	% DISTRIBUTION	VALUE STOLEN
RESIDENCE	NIGHT	2002	7,045	+5.4	20.0	\$ 6,088,399
		2001	6,687	+5.5	19.3	\$ 6,396,379
		2000	6,336	-7.4	20.0	\$ 5,829,635
	DAY	2002	9,141	-2.1	26.0	\$11,659,401
		2001	9,338	+19.4	27.0	\$12,342,701
		2000	7,820	-15.7	24.7	\$ 9,095,324
	UNKNOWN	2002	10,103	-2.5	28.7	\$15,069,067
		2001	10,366	+9.5	30.0	\$14,303,587
		2000	9,468	-2.3	29.9	\$13,009,680
TOTAL		2002	26,289	-0.4	74.7	\$32,816,867
		2001	26,391	+11.7	76.3	\$33,042,667
		2000	23,624	-8.4	74.6	\$27,934,639
NON - RESIDENCE	NIGHT	2002	3,990	+4.3	11.3	\$ 5,225,747
		2001	3,827	-2.8	11.1	\$ 4,581,480
		2000	3,939	-8.8	12.4	\$ 4,564,700
	DAY	2002	964	+4.4	2.7	\$ 1,879,723
		2001	923	-1.6	2.7	\$ 944,857
		2000	938	+7.8	3.0	\$ 1,010,289
	UNKNOWN	2002	3,928	+14.6	11.2	\$ 7,090,173
		2001	3,428	+8.5	9.9	\$ 5,909,740
		2000	3,160	-9.0	10.0	\$ 6,061,635
TOTAL		2002	8,882	+8.6	25.3	\$14,195,643
		2001	8,178	+1.8	23.7	\$11,436,077
		2000	8,037	-7.2	25.4	\$11,636,624
GRAND TOTAL		2002	35,171	+1.7	100.0	\$47,012,510
		2001	34,569	+9.2	100.0	\$44,478,744
		2000	31,661	-8.1	100.0	\$39,571,263

OKLAHOMA STATE BUREAU OF INVESTIGATION

LARCENY

Definition: The unlawful taking of property of another with intent to deprive him/her of ownership without the use of force, violence, or fraud.

For reporting purposes, larcenies are specifically categorized in crimes resulting from: (1) pocket picking, (2) purse snatching, (3) shoplifting, (4) theft from a motor vehicle, (5) theft of motor vehicle parts and accessories, (6) bicycle theft, (7) theft from buildings, and (8) theft from any coin operated machine. Any remaining crimes of theft are classified in the "all other" category.

SUMMARY ANALYSIS

A total of 100,185 larcenies was reported by law enforcement agencies.

Larceny accounted for 67.6% of all non-violent crimes and 60.5% of all index crimes reported.

There were 13,574 larcenies cleared by arrest or exceptional means for a clearance rate of 13.5%.

At 9.1%, the 13-year-old to 14-year-old age category range reflected the largest number of larceny arrests.

Persons under the age of 18 were accountable for 36.8% of all larceny arrests and 3.2% of larceny clearances.

Of all persons arrested, 67.5% were White, 26.2% were Black, 5.6% were Indian, and 0.7% were Asian.

The value of property stolen in larceny offenses totaled \$58,179,929, representing 35.0% of the total value of property stolen.

OKLAHOMA STATE BUREAU OF INVESTIGATION

LARCENY BY CLASSIFICATION

CLASSIFICATION	YEAR	NUMBER OF OFFENSES	% CHANGE	% DISTRIBUTION	VALUE STOLEN
POCKET PICKING	2002	289	0.0	0.3	\$ 74,347
	2001	289	-2.0	0.3	\$ 87,732
	2000	295	-1.3	0.3	\$ 50,727
PURSE SNATCHING	2002	452	+17.4	0.5	\$ 166,366
	2001	385	+0.8	0.4	\$ 96,275
	2000	382	-28.6	0.4	\$ 71,855
SHOPLIFTING	2002	12,440	+10.5	12.4	\$ 1,275,020
	2001	11,258	-0.1	11.9	\$ 1,264,020
	2000	11,272	-14.2	11.7	\$ 1,256,652
FROM MOTOR VEHICLES	2002	22,170	+11.2	22.1	\$13,415,332
	2001	19,930	+1.9	21.1	\$11,343,452
	2000	19,564	-4.3	20.4	\$10,419,382
MOTOR VEHICLE PARTS AND ACCESSORIES	2002	9,088	+18.2	9.1	\$ 3,936,208
	2001	7,691	+7.1	8.1	\$ 3,166,922
	2000	7,178	-4.9	7.5	\$ 2,989,130
BICYCLES	2002	3,215	-5.5	3.2	\$ 576,355
	2001	3,403	-9.9	3.6	\$ 634,445
	2000	3,776	-10.8	3.9	\$ 655,103
FROM BUILDINGS	2002	10,953	+1.2	10.9	\$ 9,920,572
	2001	10,818	+8.1	11.4	\$ 8,172,677
	2000	10,010	-6.2	10.4	\$ 7,095,204
FROM COIN OPERATED MACHINES	2002	546	-7.6	0.5	\$ 356,208
	2001	591	+16.1	0.6	\$ 203,759
	2000	509	+3.2	0.5	\$ 145,263
ALL OTHERS	2002	41,032	+2.2	41.0	\$28,459,521
	2001	40,162	-6.9	42.5	\$31,097,031
	2000	43,130	+19.0	44.9	\$25,607,996
TOTAL	2002	100,185	+6.0	100.0	\$58,179,929
	2001	94,527	-1.7	100.0	\$56,066,313
	2000	96,116	+2.7	100.0	\$48,291,312

OKLAHOMA STATE BUREAU OF INVESTIGATION

LARCENY OFFENSES BY MONTH

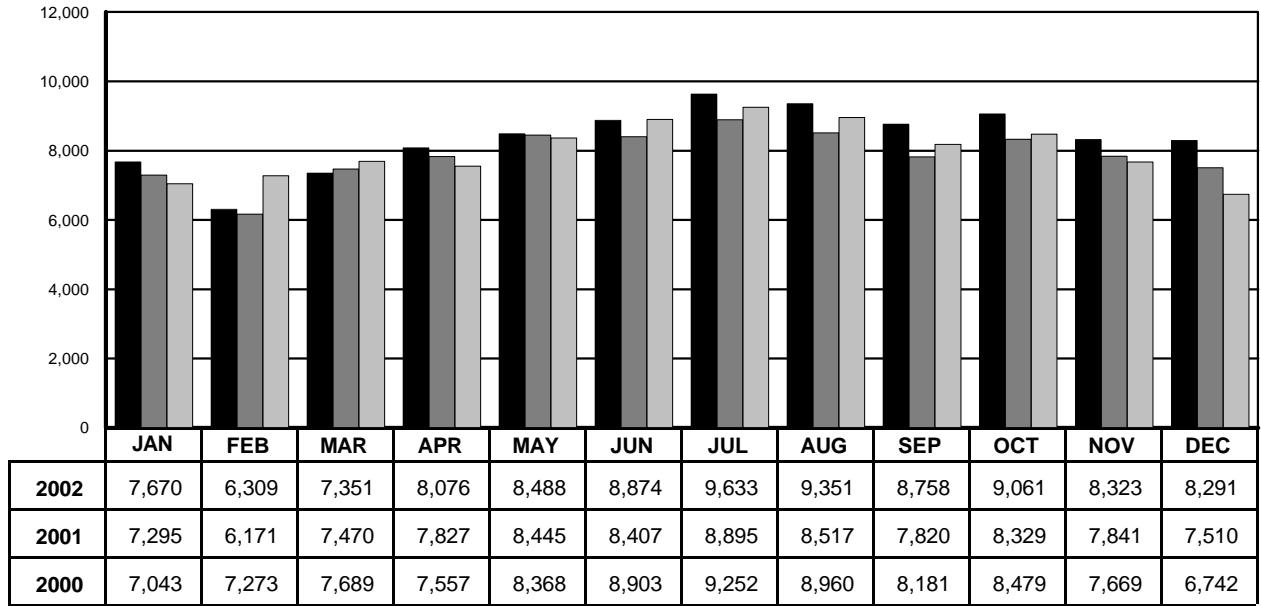

2002
 2001
 2000

LARCENY OFFENSES BY VALUE

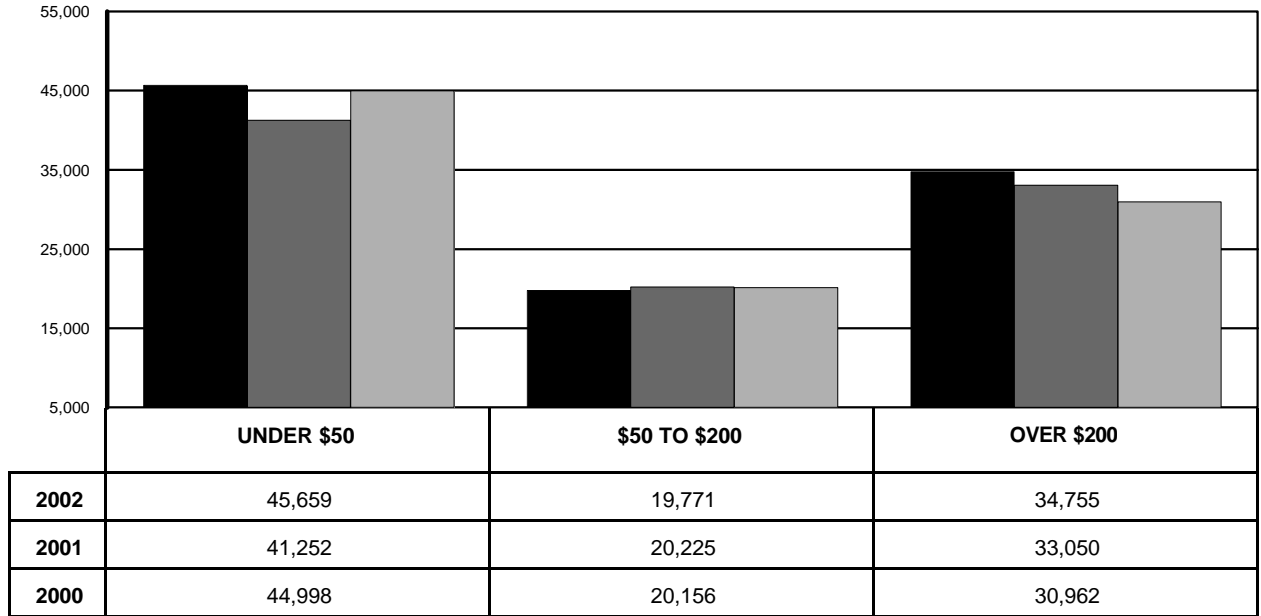

2002
 2001
 2000

OKLAHOMA STATE BUREAU OF INVESTIGATION

MOTOR VEHICLE THEFT

Definition: The unlawful taking or attempted taking of a motor vehicle.

The term "motor vehicle" includes those self-propelled vehicles which run on a land surface and not on rails.

Thefts of farm equipment, bulldozers, airplanes, and construction equipment are not included in the definition of a motor vehicle. Joyriding is included in this category.

Motor vehicle theft is divided into three categories: (1) autos; (2) trucks and buses; and (3) other vehicles.

SUMMARY ANALYSIS

A total of 12,772 motor vehicle thefts was reported by law enforcement agencies in 2002, representing a total value of \$57,892,025.

Motor vehicle theft made up 8.6% of all non-violent crimes and 7.7% of all index crimes reported.

A total of 2,176 motor vehicle thefts was cleared by arrest or exceptional means for a clearance rate of 17.0%.

At 9.9%, the 18-year-old age category accounted for the highest percentage of all those arrested for motor vehicle theft.

Juvenile arrests accounted for 30.6% of all motor vehicle theft arrests. Of the juvenile arrests, 42.7% were of 13, 14, and 15 year old offenders.

Of all persons arrested, 59.5% were White, 31.0% were Black, 9.2% were Indian, and 0.3% were Asian.

The recovery rate for motor vehicle theft was 64.0% with 8,176 recovered.

The average value of motor vehicles stolen during 2002 was \$4,532.73.

OKLAHOMA STATE BUREAU OF INVESTIGATION

MOTOR VEHICLE THEFT BY MONTH

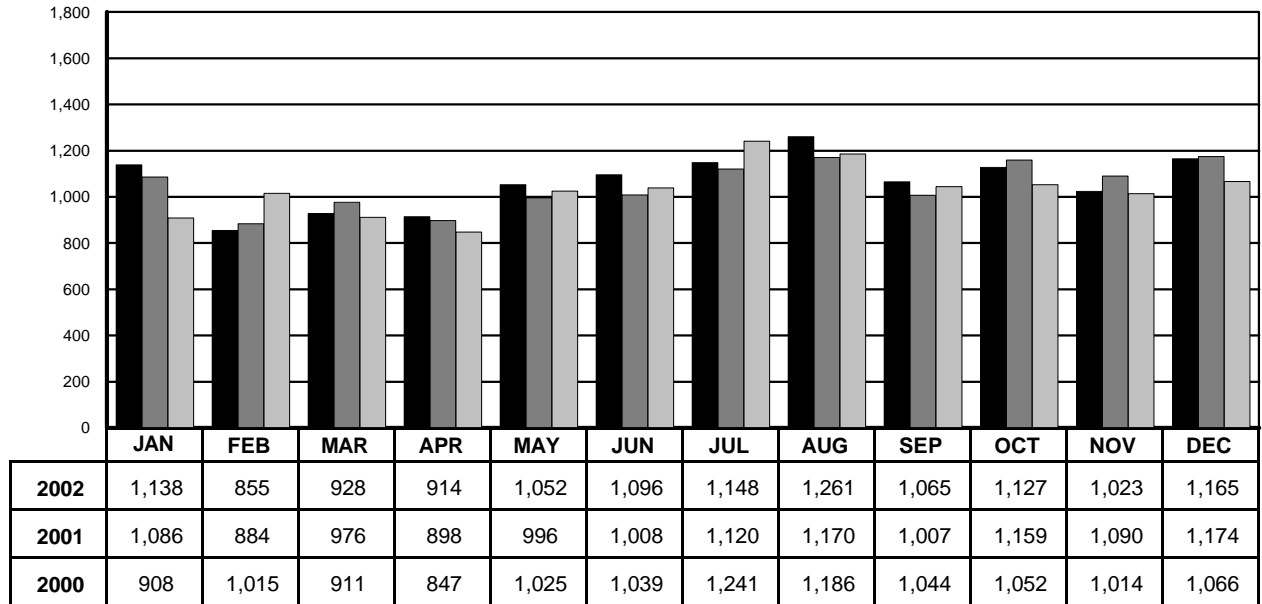

2002
 2001
 2000

MOTOR VEHICLE THEFT BY TYPE

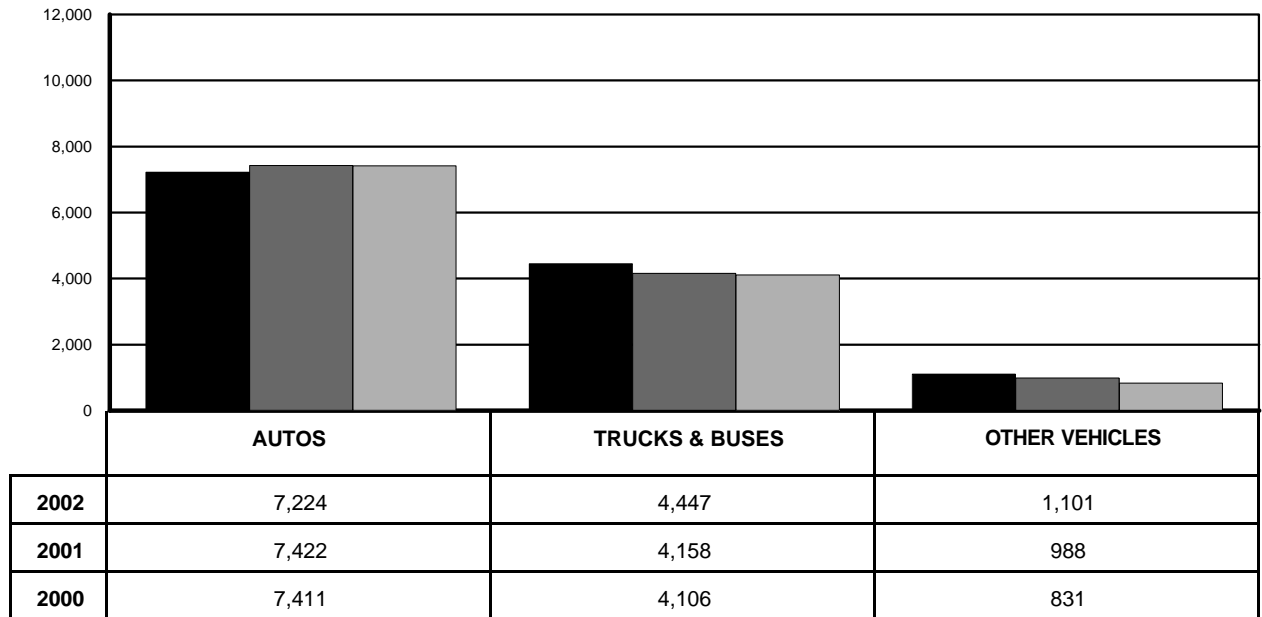

2002
 2001
 2000

OKLAHOMA STATE BUREAU OF INVESTIGATION

ARSON

Definition: Any willful or malicious burning, or attempt to burn, with or without intent to defraud.

The term "Arson" applies only to those fires determined through investigation to have been willfully or maliciously set.

Attempts to burn are included in the arson report, but fires of suspicious or unknown origin are not.

SUMMARY ANALYSIS

A total of 1,121 cases of arson was reported by law enforcement agencies in 2002.

Of those reported, 645 were structural, 308 were mobile, and 168 accounted for all others.

Arson clearances by arrest or exceptional means totaled 288, for a clearance rate of 25.7%. Persons under 18 years of age accounted for 143 of those clearances.

The total estimated value of property damaged by reported arson in 2002 was \$15,880,600. This is an increase of 19.1% from the \$13,337,584 worth of property damaged by arson in 2001.

The guidelines used by fire departments to report arson to the State Fire Marshal's Office differ from those in which the Uniform Crime Reporting Program obtains its data from law enforcement agencies. For more information on arson, you may contact the Oklahoma Fire Incident Reporting System (OFIRS) at:

OFIRS
State Fire Marshal's Office
4545 N. Lincoln Blvd., Suite 280
Oklahoma City, OK 73105
405-522-5012

OKLAHOMA STATE BUREAU OF INVESTIGATION

ARSON BY CLASSIFICATION

CLASSIFICATION	YEAR	NUMBER OF OFFENSES	% CHANGE	ESTIMATED VALUE OF DAMAGED PROPERTY
STRUCTURAL				
SINGLE OCCUPANCY RESIDENTIAL	2002	369	+1.9	\$ 6,804,519
	2001	362	-4.2	\$ 4,928,214
	2000	378	-6.2	\$ 5,119,345
OTHER RESIDENTIAL	2002	72	-28.7	\$ 1,564,741
	2001	101	-11.4	\$ 1,235,165
	2000	114	+40.7	\$ 5,757,858
STORAGE	2002	57	+1.8	\$ 509,840
	2001	56	-20.0	\$ 376,255
	2000	70	-9.1	\$ 501,627
INDUSTRIAL/MANUFACTURING	2002	5	0.0	\$ 78,000
	2001	5	-44.4	\$ 410,600
	2000	9	+50.0	\$ 399,855
OTHER COMMERCIAL	2002	41	-12.8	\$ 1,230,097
	2001	47	+6.8	\$ 2,043,955
	2000	44	-22.8	\$ 2,445,872
COMMUNITY/PUBLIC	2002	64	+1.6	\$ 3,649,924
	2001	63	+23.5	\$ 2,458,908
	2000	51	-12.1	\$ 601,580
ALL OTHER STRUCTURES	2002	37	+19.4	\$ 103,985
	2001	31	+14.8	\$ 201,226
	2000	27	-30.8	\$ 101,130
TOTAL	2002	645	-3.0	\$ 13,941,106
	2001	665	-4.0	\$ 11,654,323
	2000	693	-3.9	\$ 14,927,267
MOBILE				
MOTOR VEHICLES	2002	244	+0.8	\$ 1,393,422
	2001	242	-10.7	\$ 1,297,121
	2000	271	+1.1	\$ 1,588,005
OTHER MOBILE PROPERTY	2002	64	+48.8	\$ 351,652
	2001	43	+4.9	\$ 305,350
	2000	41	-29.3	\$ 326,251
TOTAL	2002	308	+8.1	\$ 1,745,074
	2001	285	-8.7	\$ 1,602,471
	2000	312	-4.3	\$ 1,914,256
TOTAL OTHERS				
OTHER	2002	168	+7.7	\$ 194,420
	2001	156	-44.5	\$ 80,790
	2000	281	+2.2	\$ 289,594
GRAND TOTAL	2002	1,121	+1.4	\$ 15,880,600
	2001	1,106	-14.0	\$ 13,337,584
	2000	1,286	-2.7	\$ 17,131,117

IV
PROPERTY
STOLEN AND
RECOVERED

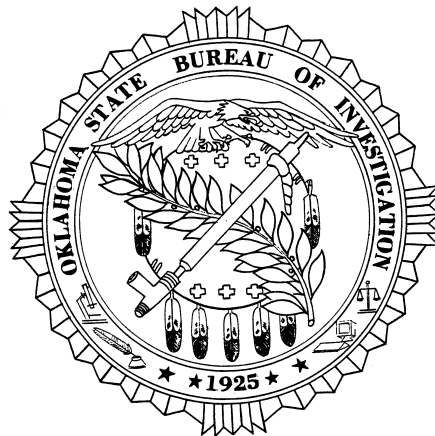

OKLAHOMA STATE BUREAU OF INVESTIGATION

PROPERTY

Each month law enforcement agencies submit supplementary data pertaining to crimes in which money or property is stolen. These figures are subsequently compiled and analyzed and the resultant figures provide information concerning the value of property stolen and recovered by type of property and offense.

The total value of property stolen in Oklahoma during 2002 was \$166,413,095. This is an increase of \$4,625,940 or 2.9% more than the previous year.

Law enforcement agencies recovered approximately 5.6% less property in 2002 with \$39,884,188 or 24.0% of the total property stolen.

**VALUE OF PROPERTY
STOLEN BY TYPE**

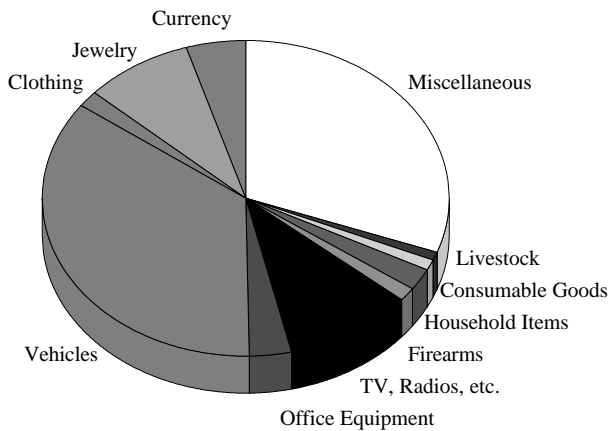

**VALUE OF PROPERTY STOLEN
& RECOVERED BY TYPE**

CATEGORY	VALUE STOLEN	VALUE RECOVERED
Currency	7,999,340	402,837
Jewelry	14,071,384	492,269
Clothing	2,662,638	329,778
Vehicles	58,905,187	34,150,090
Office Equipment	5,699,036	220,791
TV, Radios, etc.	16,920,843	513,107
Firearms	2,397,910	128,663
Household Items	3,811,819	137,790
Consumable Goods	1,907,889	194,803
Livestock	1,136,205	128,236
Miscellaneous	50,900,844	3,185,824
TOTAL	166,413,095	39,884,188

OKLAHOMA STATE BUREAU OF INVESTIGATION

VALUE OF PROPERTY STOLEN - RECOVERED BY MONTH

MONTH	VALUE STOLEN	VALUE RECOVERED
January	12,944,495	3,657,471
February	11,429,037	2,757,770
March	13,033,311	2,965,888
April	12,992,262	2,989,299
May	15,678,461	3,158,377
June	13,755,491	3,320,546
July	14,048,287	3,106,650
August	14,665,672	4,302,329
September	13,915,678	3,110,879
October	14,549,090	3,534,144
November	13,768,300	3,333,294
December	15,633,011	3,647,541
Total	166,413,095	39,884,188

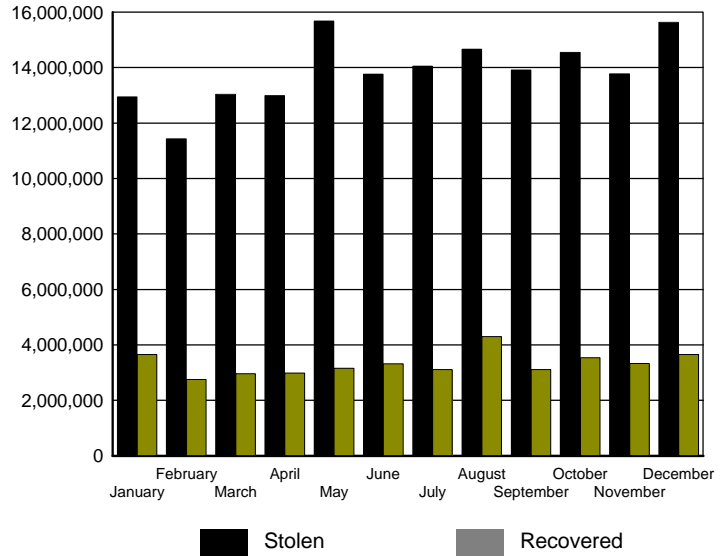

VALUE OF PROPERTY STOLEN - BY OFFENSE

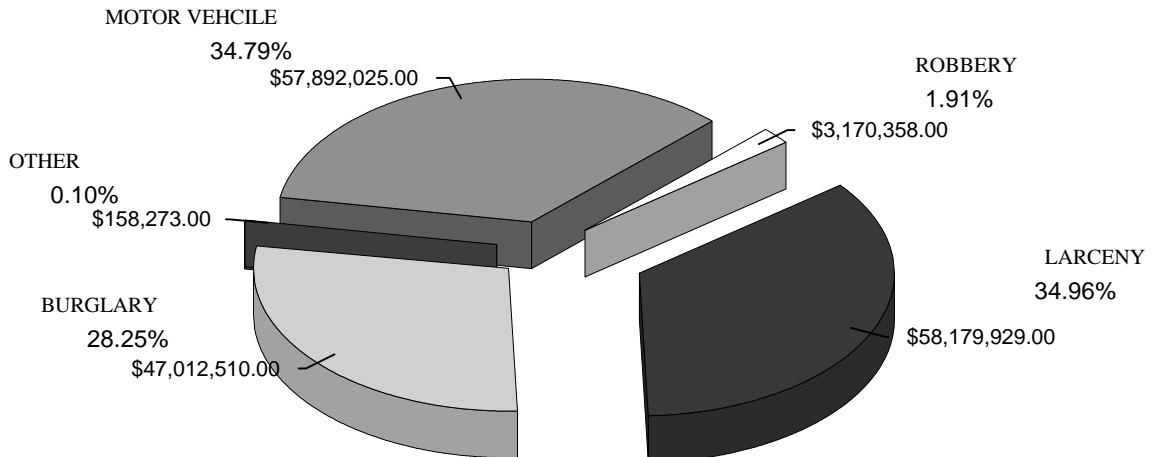

OKLAHOMA STATE BUREAU OF INVESTIGATION

PROPERTY STOLEN - RECOVERED BY MONTH

MONTH	YEAR	STOLEN	% CHANGE	RECOVERED	% CHANGE
JANUARY	2002	\$12,944,495	-1.3	\$3,657,471	-9.6
	2001	\$13,112,626	+10.8	\$4,045,066	+48.1
	2000	\$11,831,451	-8.0	\$2,731,871	-25.0
FEBRUARY	2002	\$11,429,037	+9.0	\$2,757,770	-13.4
	2001	\$10,487,943	-11.2	\$3,184,768	-3.8
	2000	\$11,813,013	+21.8	\$3,310,708	+40.6
MARCH	2002	\$13,033,311	+0.6	\$2,965,888	-22.1
	2001	\$12,955,789	+10.8	\$3,809,242	+17.5
	2000	\$11,695,310	+8.8	\$3,242,877	+10.2
APRIL	2002	\$12,992,262	+5.7	\$2,989,299	-3.4
	2001	\$12,292,022	+12.1	\$3,094,602	+13.9
	2000	\$10,964,449	+2.3	\$2,716,084	-13.9
MAY	2002	\$15,678,461	+15.6	\$3,158,377	-13.6
	2001	\$13,568,511	+12.3	\$3,654,038	+6.6
	2000	\$12,078,938	-18.8	\$3,427,428	+5.1
JUNE	2002	\$13,755,491	+6.5	\$3,320,546	+10.8
	2001	\$12,916,819	+7.5	\$2,997,156	-10.9
	2000	\$12,016,855	+4.4	\$3,363,039	-8.7
JULY	2002	\$14,048,287	-5.5	\$3,106,650	-22.3
	2001	\$14,871,567	+0.2	\$3,995,961	-1.7
	2000	\$14,836,794	+11.0	\$4,064,820	-0.1
AUGUST	2002	\$14,665,672	+0.3	\$4,302,329	+9.9
	2001	\$14,616,233	+3.5	\$3,915,172	-19.1
	2000	\$14,124,058	+9.3	\$4,836,845	+30.5
SEPTEMBER	2002	\$13,915,678	+5.6	\$3,110,879	-8.3
	2001	\$13,182,988	-3.3	\$3,390,812	-2.4
	2000	\$13,639,131	+11.6	\$3,474,750	-11.1
OCTOBER	2002	\$14,549,090	-4.4	\$3,534,144	-3.6
	2001	\$15,222,655	+12.7	\$3,667,968	+4.6
	2000	\$13,510,496	+3.8	\$3,507,404	-5.2
NOVEMBER	2002	\$13,768,300	-6.9	\$3,333,294	+1.9
	2001	\$14,781,560	+21.5	\$3,269,570	+5.0
	2000	\$12,170,264	-10.2	\$3,112,674	-18.9
DECEMBER	2002	\$15,633,011	+13.5	\$3,647,541	+13.7
	2001	\$13,778,442	+19.8	\$3,207,174	-0.4
	2000	\$11,504,412	-3.0	\$3,219,171	-2.7
TOTAL	2002	\$166,413,095	+2.9	\$39,884,188	-5.6
	2001	\$161,787,155	+7.7	\$42,231,529	+3.0
	2000	\$150,185,171	+1.9	\$41,007,671	-1.4

V

ARREST

AND

CLEARANCE DATA

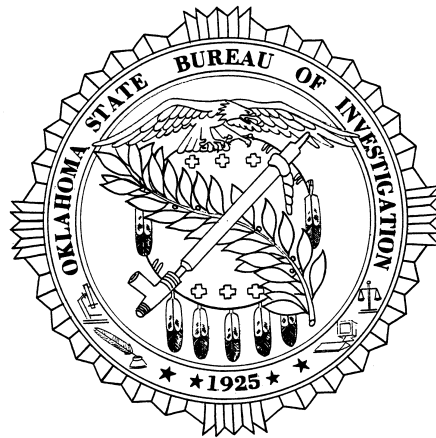

OKLAHOMA STATE BUREAU OF INVESTIGATION

ARREST AND CLEARANCE DATA

The Oklahoma Uniform Crime Reporting Program requests the monthly submission of data concerning persons arrested in Oklahoma. A record of total arrest activity for criminal acts in both Part I and Part II classifications is collected and analyzed according to age, sex, and race. With the exception of arrests for driving under the influence and transporting an open container, traffic arrests are not reported.

A person is counted on the monthly arrest report each time he is arrested. A person may be arrested several times during the month for such crimes as public drunkenness, disorderly conduct, and similar violations. It should be noted that if a person is charged with several different crimes at the same time, the arrest is shown only for the highest offense the person committed at that time.

A total of 166,395 arrests was reported in 2002. Juveniles accounted for 23,970 of those arrested. The number of arrests increased by 1,822 or 1.1% from 2001.

An analysis of reported arrests for 2002 indicates 13.8% of all arrests occurred in the index offenses. The highest clearance rate of a particular index offense occurred in the murder category with 96.3% being cleared by arrests or exceptional means.

Alcohol related arrests (driving under the influence, drunkenness, and other liquor law violations) constituted 30.0% of the total arrests reported in 2002. This percentage represents the arrest of 2,068 juveniles and 47,817 adults. The highest percentage of arrests occurred in the category of drunkenness which represented 49.3% of arrests made for all alcohol related offenses.

CLEARANCE RATE

For crime reporting purposes, a crime index offense is cleared when: (1) a law enforcement agency has identified the offender; (2) there is enough evidence to charge the offender; and (3) the offender is actually taken into custody. The arrest of one person may clear several crimes or the arrest of several persons may clear only one crime. The number of arrests and the number of clearances for any particular offense should not be compared as the numbers may not, and likely will not, be the same.

Clearances are also reported when some element beyond law enforcement control precludes the filing of formal charges. Examples include the death of the offender, particularly in the case of a murder/suicide, the handling of juveniles, and other exceptional circumstances.

OKLAHOMA STATE BUREAU OF INVESTIGATION

PERCENTAGE OF INDEX CRIMES CLEARED

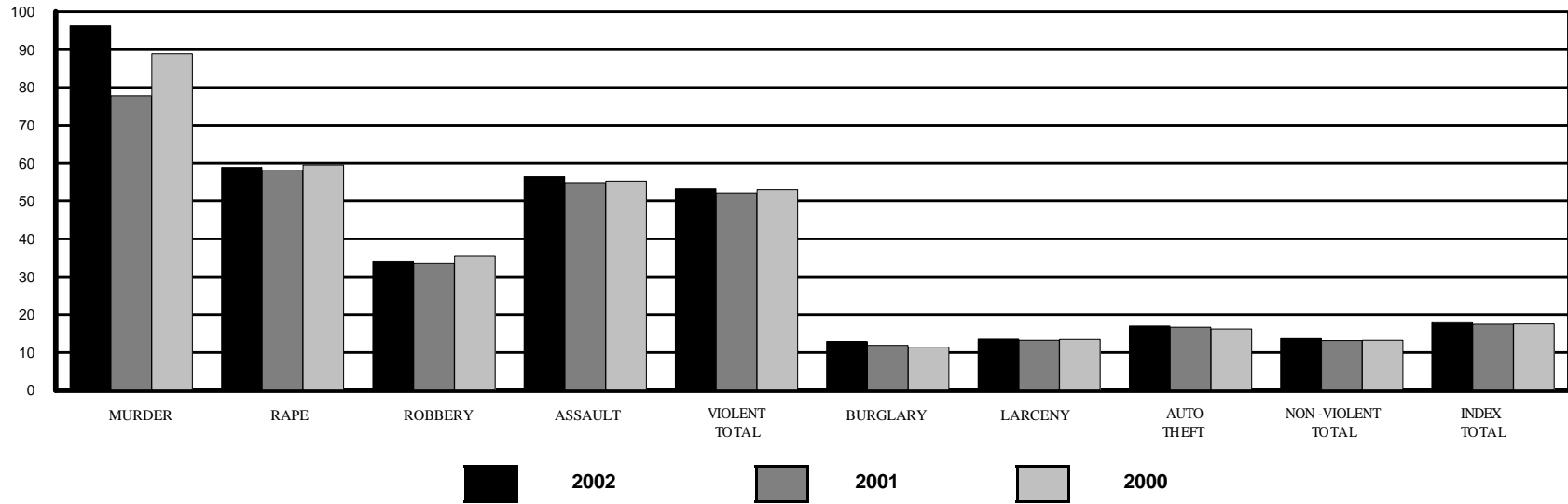

YEAR	MURDER	RAPE	ROBBERY	ASSAULT	VIOLENT TOTAL	BURGLARY	LARCENY	AUTO THEFT	NON-VIOLENT TOTAL	INDEX TOTAL
2002	96.3	58.9	34.1	56.5	53.3	12.9	13.5	17.0	13.7	17.9
2001	77.8	58.2	33.6	54.9	52.1	11.9	13.2	16.7	13.2	17.5
2000	89.0	59.6	35.4	55.3	53.0	11.4	13.5	16.2	13.3	17.6

OKLAHOMA STATE BUREAU OF INVESTIGATION

CLEARANCE BY AGE

AGE 17 & UNDER

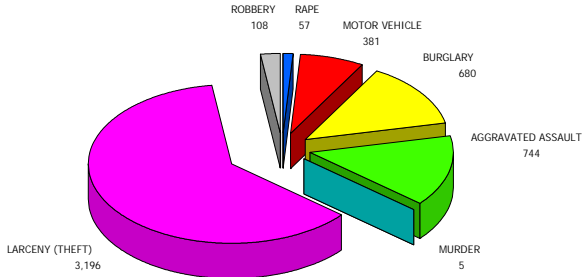

AGE 18 & OVER

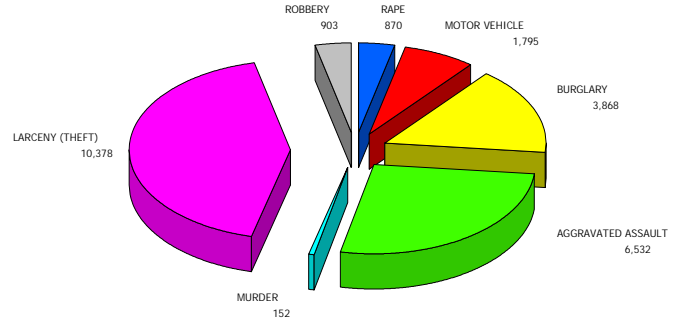

CLEARANCE DATA

OFFENSE	NUMBER OF OFFENSES	% CLEARED	NUMBER OF OFFENSES CLEARED BY ARREST OR EXCEPTIONAL MEANS			% AGE 17 & UNDER	% AGE 18 & OVER
			TOTAL	AGE 17 & UNDER	AGE 18 & OVER		
MURDER	163	96.3	157	5	152	3.1	93.3
RAPE	1,573	58.9	927	57	870	3.6	55.3
ROBBERY	2,966	34.1	1,011	108	903	3.6	30.4
AGGRAVATED ASSAULT	12,885	56.5	7,276	744	6,532	5.8	50.7
VIOLENT TOTAL	17,587	53.3	9,371	914	8,457	5.2	48.1
BURGLARY	35,171	12.9	4,548	680	3,868	1.9	11.0
LARCENY (THEFT)	100,185	13.5	13,574	3,196	10,378	3.2	10.4
MOTOR VEHICLE	12,772	17.0	2,176	381	1,795	3.0	14.1
NON VIOLENT TOTAL	148,128	13.7	20,298	4,257	16,041	2.9	10.8
TOTAL	165,715	17.9	29,669	5,171	24,498	3.1	14.8

OKLAHOMA STATE BUREAU OF INVESTIGATION

JUVENILE ARREST OVERVIEW

The following overview deals primarily with juvenile arrests for the past ten years. The first chart depicts a comparison of 1993 and 2002 arrest totals in specific categories.

JUVENILE ARRESTS - A TEN-YEAR COMPARISON

ARRESTS	1993	2002	% CHANGE
JUVENILES	25,000	23,970	-4.1
VIOLENT CRIMES	1,272	996	-21.7
NON - VIOLENT CRIMES (WITH ARSON)	10,475	6,024	-42.5
DRUG ABUSE TOTAL	776	1,766	+127.6
DRUG SALE/MFG.	158	198	+25.3
DRUG POSSESSION	618	1,568	+153.7
ALCOHOL RELATED	1,861	2,068	+11.1

TOTAL JUVENILE ARRESTS

YEAR	TOTAL
1993	25,000
1994	27,646
1995	29,551
1996	30,698
1997	32,283
1998	31,595
1999	27,899
2000	25,869
2001	24,885
2002	23,970

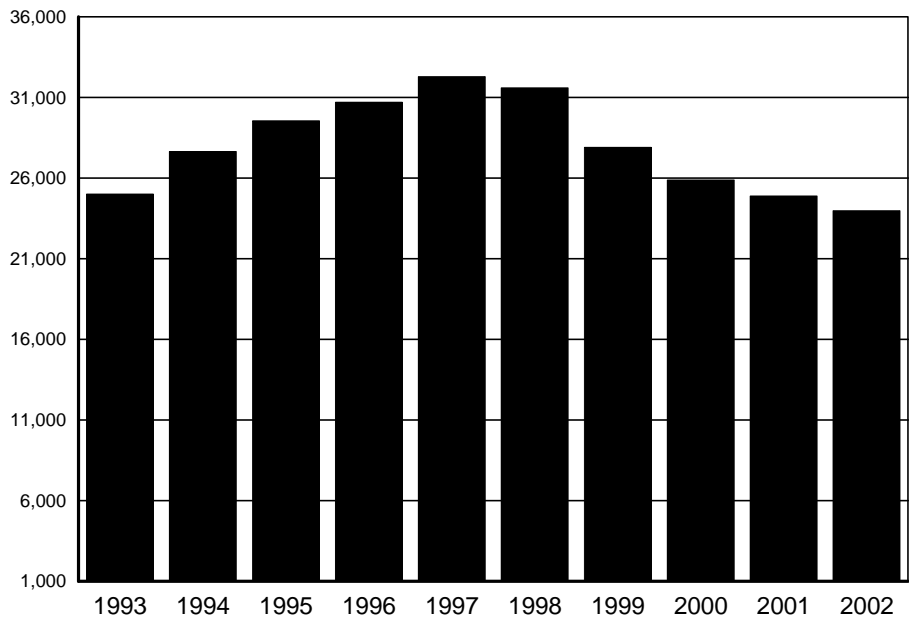

In 2002, juveniles accounted for 14.4% of all persons arrested for all crimes.

OKLAHOMA STATE BUREAU OF INVESTIGATION

JUVENILE INDEX CRIME ARRESTS

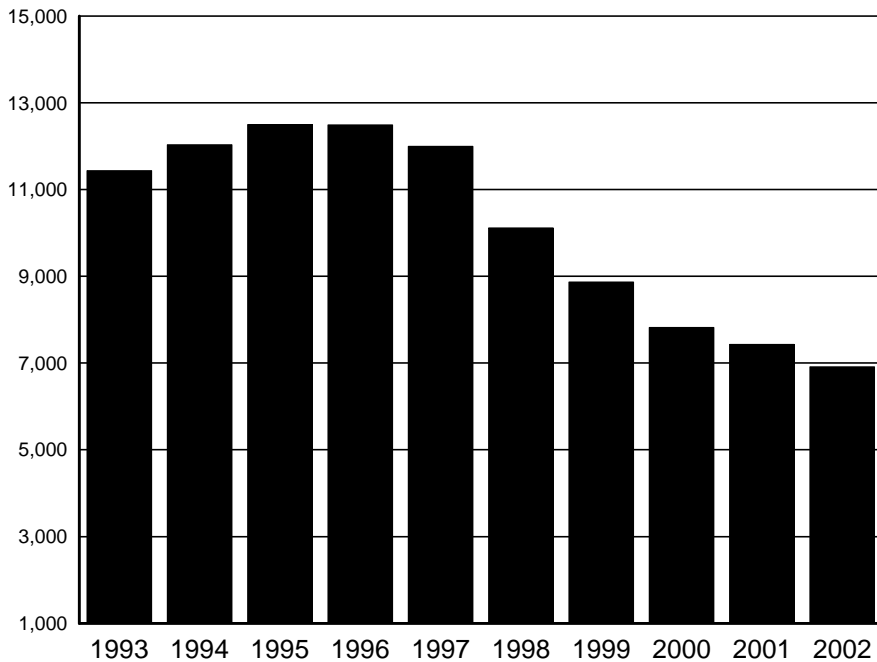

YEAR	CRIMES
1993	11,436
1994	12,035
1995	12,496
1996	12,490
1997	11,993
1998	10,117
1999	8,869
2000	7,817
2001	7,428
2002	6,916

The offense of larceny makes up 63.1% of all juvenile arrests for index crimes in the year 2002.

JUVENILE WEAPONS LAW VIOLATIONS

YEAR	ARRESTS
1993	613
1994	624
1995	510
1996	449
1997	467
1998	466
1999	359
2000	378
2001	297
2002	339

The 2002 figure of 339 arrests is a decrease of 44.7% over the arrests reported in 1993.

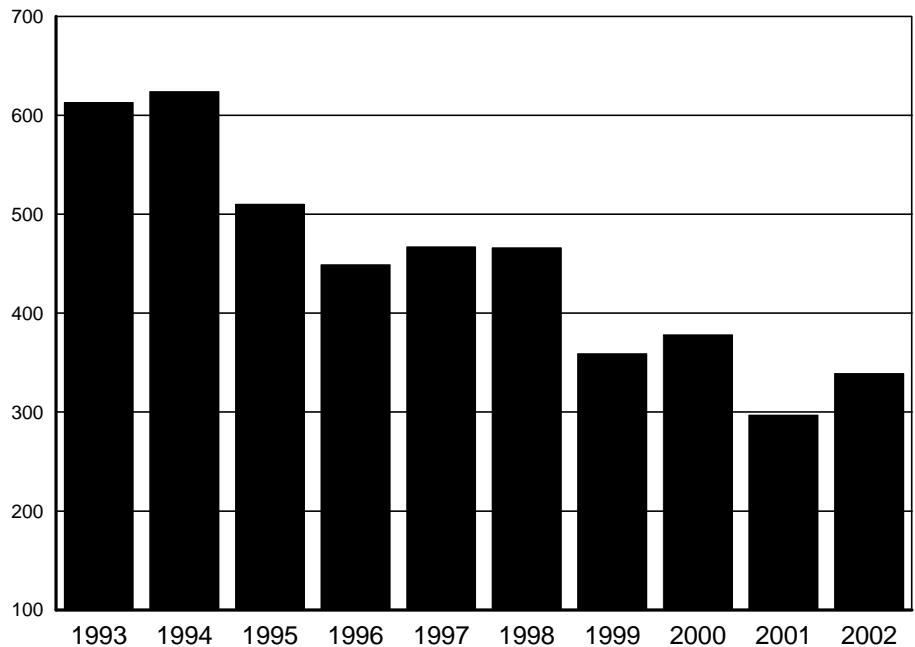

OKLAHOMA STATE BUREAU OF INVESTIGATION

JUVENILE DRUG RELATED ARRESTS

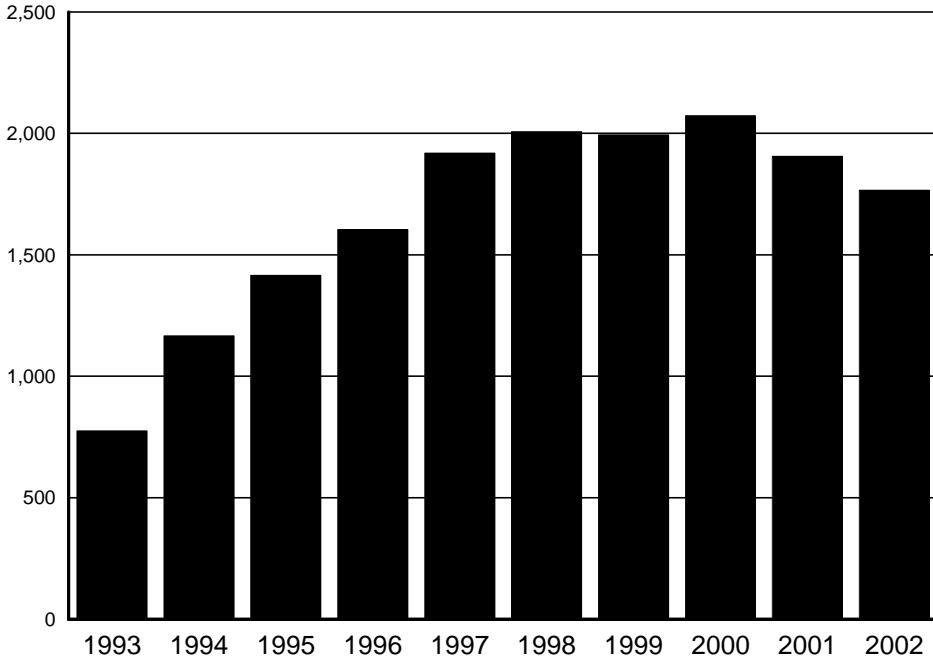

YEAR	ARRESTS
1993	776
1994	1,167
1995	1,416
1996	1,604
1997	1,919
1998	2,007
1999	1,993
2000	2,072
2001	1,906
2002	1,766

There has been a 14.8% decrease from 2000 in the number of drug related arrests reported. The figure for 2000 is the highest in this ten-year comparison.

JUVENILE ALCOHOL RELATED ARRESTS

YEAR	ARRESTS
1993	1,861
1994	1,723
1995	1,896
1996	2,024
1997	2,269
1998	2,725
1999	2,298
2000	2,103
2001	2,091
2002	2,068

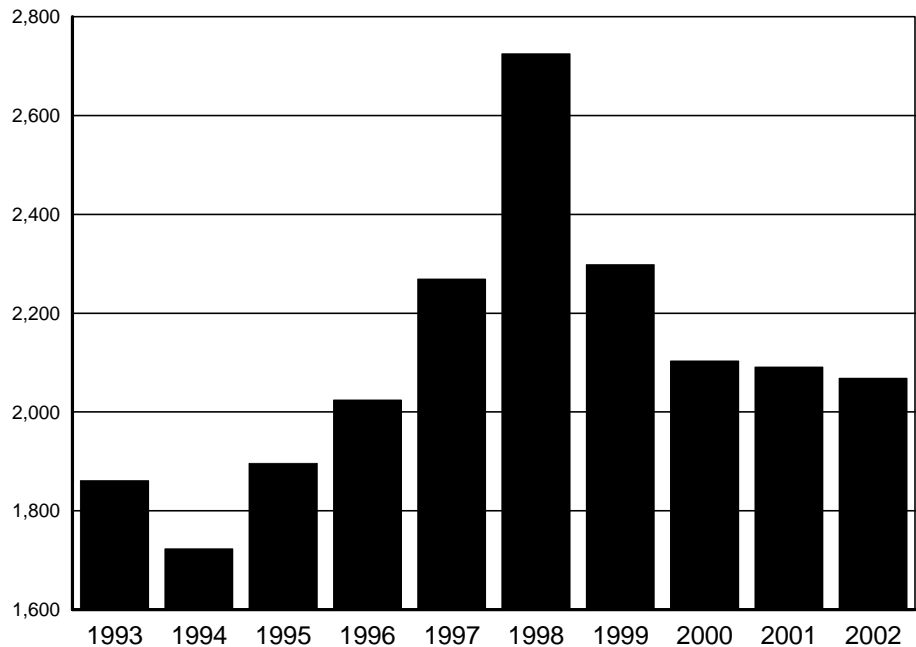

Alcohol related arrests were at their lowest in 1994. There was a 24.1% decrease from 1998 to 2002 .

OKLAHOMA STATE BUREAU OF INVESTIGATION

NUMBER OF JUVENILE ARRESTS STATE OF OKLAHOMA

2002

OFFENSE	S E X	AGE						TOTAL	RACE				ETHNICITY	
		UNDER 10	10 - 12	13 - 14	15	16	17		WHITE	BLACK	INDIAN	ASIAN	Hispanic	Non Hispanic
Murder	M	0	1	1	1	4	3	10	6	4	0	0	4	6
	F	0	0	0	3	0	0	3	2	1	0	0	1	2
Manslaughter by Negligence	M	0	0	0	0	0	1	1	1	0	0	0	0	1
	F	1	0	0	0	0	0	1	1	0	0	0	0	1
Forcible Rape	M	0	1	15	14	12	14	56	27	23	6	0	5	51
	F	0	0	0	0	0	0	0	0	0	0	0	0	0
Robbery	M	0	2	26	23	43	49	143	48	85	10	0	7	136
	F	0	1	3	1	2	7	14	4	8	2	0	1	13
Aggravated Assault	M	19	65	146	84	113	167	594	396	140	57	1	56	538
	F	3	12	59	31	33	38	176	93	69	14	0	13	163
Burglary-Breaking and Entering	M	23	91	256	180	181	193	924	591	270	55	8	46	878
	F	3	11	25	15	18	17	89	74	12	3	0	6	83
Larceny-Theft (Except Motor Vehicle Theft)	M	70	268	594	439	565	552	2,488	1,715	622	132	19	143	2,345
	F	15	134	486	395	460	386	1,876	1,214	553	101	8	80	1,796
Motor Vehicle Theft	M	3	20	88	87	129	116	443	222	174	47	0	39	404
	F	0	1	33	24	21	21	100	61	22	17	0	10	90
Other Assaults	M	22	90	212	193	177	244	938	658	217	62	1	81	857
	F	3	31	162	95	84	87	462	280	139	40	3	30	432
Arson	M	10	29	27	11	6	9	92	75	15	2	0	6	86
	F	0	2	7	1	1	1	12	9	3	0	0	0	12

OKLAHOMA STATE BUREAU OF INVESTIGATION

NUMBER OF JUVENILE ARRESTS STATE OF OKLAHOMA

2002

OFFENSE	SEX	AGE						TOTAL	RACE				ETHNICITY	
		UNDER 10	10 - 12	13 - 14	15	16	17		WHITE	BLACK	INDIAN	ASIAN	Hispanic	Non Hispanic
Forgery and Counterfeiting	M	0	2	5	4	5	12	28	24	2	2	0	0	28
	F	0	0	1	1	4	13	19	14	4	1	0	0	19
Fraud	M	0	0	5	9	12	30	56	26	29	1	0	6	50
	F	0	0	2	4	11	12	29	11	15	2	1	0	29
Embezzlement	M	0	1	3	3	3	15	25	16	9	0	0	3	22
	F	0	0	1	1	1	11	14	11	3	0	0	2	12
Stolen Property; Buying,Receiving,Possessing	M	2	7	49	45	54	76	233	149	74	10	0	12	221
	F	0	1	13	12	11	13	50	27	15	8	0	1	49
Vandalism	M	37	115	153	75	105	90	575	457	77	40	1	34	541
	F	4	12	52	12	20	17	117	83	20	14	0	6	111
Weapons; Carrying, Possessing, etc.	M	7	23	63	51	71	93	308	204	86	17	1	37	271
	F	1	4	7	6	4	9	31	19	8	4	0	2	29
Prostitution and Commercialized Vice	M	0	0	1	0	1	0	2	2	0	0	0	0	2
	F	0	0	3	0	1	2	6	4	2	0	0	0	6
Sex Offenses	M	2	7	21	17	15	17	79	65	10	4	0	2	77
	F	0	1	0	1	2	0	4	3	1	0	0	0	4
Sales/MFG Opium or Cocaine & Their Derivatives	M	0	1	2	4	8	12	27	8	19	0	0	3	24
	F	0	0	4	1	2	7	14	6	8	0	0	1	13
Sales/MFG Marijuana	M	0	1	7	11	22	36	77	56	15	6	0	5	72
	F	0	1	3	2	2	9	17	14	3	0	0	1	16

OKLAHOMA STATE BUREAU OF INVESTIGATION

NUMBER OF JUVENILE ARRESTS STATE OF OKLAHOMA

2002

OFFENSE	SEX	AGE						TOTAL	RACE				ETHNICITY	
		UNDER 10	10 - 12	13 - 14	15	16	17		WHITE	BLACK	INDIAN	ASIAN	Hispanic	Non Hispanic
Sales/MFG Synthetic Narcotics	M	0	0	2	3	5	15	25	18	4	2	1	0	25
	F	0	0	0	0	0	8	8	8	0	0	0	0	8
Sales/MFG Other	M	0	0	1	4	4	13	22	13	9	0	0	0	22
	F	0	0	2	1	1	4	8	5	2	1	0	0	8
Possession Opium or Cocaine & Their Derivatives	M	0	2	14	24	29	48	117	44	70	3	0	10	107
	F	0	1	5	9	9	24	48	29	16	3	0	6	42
Possession Marijuana	M	3	13	106	153	323	430	1,028	828	164	34	2	70	958
	F	0	6	24	44	90	90	254	207	24	19	4	10	244
Possession Synthetic Narcotics	M	0	0	2	8	5	22	37	31	3	3	0	2	35
	F	0	1	3	1	7	12	24	22	1	1	0	0	24
Possession Other	M	0	0	4	6	14	22	46	41	3	2	0	0	46
	F	0	1	2	4	5	2	14	13	1	0	0	0	14
Numbers and Lottery	M	0	0	0	0	1	0	1	1	0	0	0	0	1
	F	0	0	0	0	0	0	0	0	0	0	0	0	0
All Other Gambling	M	0	0	0	0	0	1	1	0	1	0	0	0	1
	F	0	0	0	0	0	0	0	0	0	0	0	0	0
Offenses Against Family and Children	M	0	1	2	4	3	8	18	9	7	2	0	0	18
	F	0	2	3	0	3	3	11	7	1	2	1	0	11
Driving Under The Influence	M	0	1	5	25	126	244	401	352	19	29	1	38	363
	F	0	1	2	3	27	47	80	68	2	10	0	5	75

OKLAHOMA STATE BUREAU OF INVESTIGATION

NUMBER OF JUVENILE ARRESTS STATE OF OKLAHOMA

2002

OFFENSE	SEX	AGE						TOTAL	RACE				ETHNICITY	
		UNDER 10	10 - 12	13 - 14	15	16	17		WHITE	BLACK	INDIAN	ASIAN	Hispanic	Non Hispanic
Liquor Laws	M	2	2	24	56	138	227	449	404	21	23	1	37	412
	F	0	0	18	25	71	75	189	173	6	9	1	5	184
Drunkenness	M	2	3	55	124	208	351	743	598	34	110	1	51	692
	F	0	0	28	30	72	76	206	159	8	39	0	8	198
Disorderly Conduct	M	6	78	173	105	88	111	561	340	186	35	0	54	507
	F	1	25	91	62	47	47	273	129	131	13	0	21	252
All Other Offenses (Except Traffic)	M	31	110	467	475	686	830	2,599	1,926	520	132	21	122	2,477
	F	5	56	257	237	258	246	1,059	813	183	60	3	30	1,029
Curfew and Loitering Law Violations	M	12	87	364	443	619	699	2,224	1,602	456	157	9	147	2,077
	F	0	25	220	256	273	251	1,025	814	136	72	3	55	970
Runaway	M	14	84	245	207	207	175	932	723	135	72	2	52	880
	F	6	86	441	374	315	212	1,434	1,148	162	108	16	75	1,359

OKLAHOMA STATE BUREAU OF INVESTIGATION

NUMBER OF JUVENILE ARRESTS STATE OF OKLAHOMA

2002

OFFENSE	SEX	AGE						TOTAL	RACE				ETHNICITY	
		UNDER 10	10 - 12	13 - 14	15	16	17		WHITE	BLACK	INDIAN	ASIAN	Hispanic	Non Hispanic
SUBTOTALS FOR THE STATE OF OKLAHOMA														
TOTAL SALES/ MFG	M	0	2	12	22	39	76	151	95	47	8	1	8	143
	F	0	1	9	4	5	28	47	33	13	1	0	2	45
SALES TOTAL		0	3	21	26	44	104	198	128	60	9	1	10	188
TOTAL POSSESSION	M	3	15	126	191	371	522	1,228	944	240	42	2	82	1,146
	F	0	9	34	58	111	128	340	271	42	23	4	16	324
POSSESSION TOTAL		3	24	160	249	482	650	1,568	1,215	282	65	6	98	1,470
TOTAL DRUGS	M	3	17	138	213	410	598	1,379	1,039	287	50	3	90	1,289
	F	0	10	43	62	116	156	387	304	55	24	4	18	369
DRUG TOTAL		3	27	181	275	526	754	1,766	1,343	342	74	7	108	1,658
TOTAL GAMBLING	M	0	0	0	0	1	1	2	1	1	0	0	0	2
	F	0	0	0	0	0	0	0	0	0	0	0	0	0
GAMBLING TOTAL		0	0	0	0	1	1	2	1	1	0	0	0	2
TOTAL MALES		265	1,105	3,138	2,888	3,982	4,925	16,303	11,676	3,503	1,055	69	1,072	15,231
TOTAL FEMALES		42	415	1,957	1,651	1,855	1,747	7,667	5,525	1,559	543	40	369	7,298
GRAND TOTAL		307	1,520	5,095	4,539	5,837	6,672	23,970	17,201	5,062	1,598	109	1,441	22,529

OKLAHOMA STATE BUREAU OF INVESTIGATION

COLLECTION OF DISPOSITIONS

The Oklahoma Uniform Crime Reporting Program requires the collection of juvenile arrest dispositions as a source of meaningful information on action against juveniles who have been taken into custody or arrested by police. When adults are arrested, they are usually held for felony or misdemeanor prosecution in the appropriate court. This is not necessarily the case with juveniles. Several disposition options are available and the one chosen depends upon the seriousness of the offense and the juvenile's prior record. Many are warned by the police and released to their parents, a relative, a friend or guardian. Sometimes they are referred to the probation department or some other branch of the juvenile court. In other instances, they may be referred to welfare agencies, other police agencies, or to criminal or adult court by waiver of the juvenile court.

Here, the word "arrest" refers to the police handling of all juveniles who have committed a crime and are taken into custody when, under the same circumstances, the crime would warrant the arrest of an adult. Police "contacts" with juveniles are not counted as arrests where no offense has been committed. Instances where juveniles are taken into custody for their own protection and not because they have committed a crime, such as in neglect cases, are not listed as arrests.

JUVENILE DISPOSITIONS

DISPOSITION	2002	2001	2000
Handling within department and released (released to parents, etc.)	7,167	5,647	6,329
Referred to juvenile court or probation department	12,676	14,473	14,310
Referred to welfare agency	161	196	267
Referred to other police agency	914	944	1,353
Referred to criminal or adult court	3,115	3,654	3,636
TOTAL	24,033	24,914	25,895

OKLAHOMA STATE BUREAU OF INVESTIGATION

NUMBER OF ADULT ARRESTS STATE OF OKLAHOMA

2002

OFFENSE	SEX	AGE																TOTAL	RACE				ETHNICITY	
		18	19	20	21	22	23	24	25 - 29	30-34	35 - 39	40 - 44	45 - 49	50 - 54	55-59	60-64	65 and Over		WHITE	BLACK	INDIAN	ASIAN	Hispanic	Non Hispanic
Murder	M	6	7	10	4	11	14	10	13	18	17	13	7	3	2	2	0	137	83	43	10	1	9	128
	F	1	2	3	4	0	0	0	5	2	2	3	0	2	0	0	0	24	18	5	1	0	1	23
Manslaughter by Negligence	M	0	0	2	1	3	3	0	7	1	1	3	1	0	1	0	2	25	22	3	0	0	1	24
	F	0	1	1	0	0	0	0	0	2	1	0	1	0	0	0	0	6	4	2	0	0	0	6
Forcible Rape	M	34	20	23	23	18	20	11	47	53	47	27	20	13	13	1	4	374	246	93	31	4	36	338
	F	1	0	1	0	0	0	0	3	1	1	0	0	0	0	0	0	7	7	0	0	0	1	6
Robbery	M	62	53	40	32	25	26	22	74	81	60	37	22	4	1	1	3	543	235	289	17	2	41	502
	F	0	12	3	3	3	3	2	9	6	10	5	1	2	0	0	0	59	30	23	6	0	1	58
Aggravated Assault	M	158	157	150	161	139	160	135	547	457	430	411	255	123	64	27	29	3,403	2,334	714	327	28	228	3,175
	F	34	40	34	31	37	37	28	109	112	98	89	42	23	13	3	3	733	419	226	82	6	23	710
Burglary-Breaking and Entering	M	217	214	145	127	92	77	82	248	185	169	138	90	28	11	4	8	1,835	1,263	425	141	6	88	1,747
	F	18	18	14	9	11	19	5	36	44	44	25	7	5	1	0	1	257	184	49	24	0	3	254
Larceny-Theft (Except Motor Vehicle Theft)	M	576	475	333	262	199	155	156	522	443	430	420	274	135	61	27	33	4,501	3,103	1,064	300	34	330	4,171
	F	333	265	194	146	100	126	92	374	358	350	280	175	88	55	17	31	2,984	1,963	867	127	27	155	2,829
Motor Vehicle Theft	M	151	94	83	53	54	45	29	123	110	103	78	42	17	4	1	1	988	615	294	74	5	58	930
	F	24	14	10	15	14	21	11	40	30	33	22	6	3	1	0	0	244	158	60	25	1	5	239
Other Assaults	M	271	300	339	343	352	336	262	1,204	1,142	1,014	913	486	254	99	49	51	7,415	5,195	1,597	584	39	564	6,851
	F	86	91	85	80	82	84	73	299	264	242	223	111	47	23	6	8	1,804	1,278	334	179	13	64	1,740
Arson	M	14	8	3	5	3	2	1	11	13	9	14	3	5	2	2	0	95	79	9	7	0	3	92
	F	0	1	2	3	0	2	2	5	6	8	6	4	1	1	2	0	43	29	13	1	0	0	43
Forgery and Counterfeiting	M	44	32	21	30	16	13	18	86	76	56	38	31	12	6	0	3	482	360	102	15	5	28	454
	F	13	20	30	16	25	16	20	88	102	76	48	21	11	4	2	1	493	367	104	20	2	12	481

OKLAHOMA STATE BUREAU OF INVESTIGATION

NUMBER OF ADULT ARRESTS STATE OF OKLAHOMA

2002

OFFENSE	SEX	AGE																TOTAL	RACE				ETHNICITY	
		18	19	20	21	22	23	24	25-29	30-34	35-39	40-44	45-49	50-54	55-59	60-64	65 and Over		WHITE	BLACK	INDIAN	ASIAN	Hispanic	Non Hispanic
Fraud	M	67	84	84	90	99	77	62	280	263	239	189	118	75	29	12	9	1,777	1,281	402	87	7	100	1,677
	F	27	56	54	45	69	52	42	258	233	170	133	79	44	24	8	7	1,301	916	283	93	9	42	1,259
Embezzlement	M	23	35	24	25	16	11	8	48	37	25	34	15	12	5	6	2	326	244	72	9	1	14	312
	F	25	19	10	17	16	13	8	44	33	34	25	16	2	3	1	0	266	192	62	10	2	6	260
Stolen Property; Buying,Receiving,Possessing	M	92	79	88	57	51	45	35	128	130	126	93	50	22	12	3	4	1,015	736	213	58	8	47	968
	F	14	27	22	19	9	10	13	39	45	38	23	13	5	2	1	0	280	211	55	12	2	5	275
Vandalism	M	95	63	55	58	28	25	20	88	70	66	50	22	11	11	4	5	671	493	118	59	1	62	609
	F	12	16	14	10	9	8	9	27	26	24	19	3	2	0	1	2	182	110	54	18	0	5	177
Weapons; Carrying, Possessing, etc.	M	135	140	123	119	120	75	83	293	247	193	152	104	65	29	18	20	1,916	1,340	480	85	11	122	1,794
	F	7	14	9	11	11	9	5	35	35	27	40	20	2	5	1	2	233	168	53	12	0	7	226
Prostitution and Commercialized Vice	M	1	2	4	1	0	1	6	15	13	19	14	13	7	7	1	4	108	87	14	4	3	9	99
	F	9	4	11	6	9	5	11	23	47	34	22	10	6	3	0	0	200	124	58	15	3	6	194
Sex Offenses	M	26	23	16	29	20	21	22	80	87	111	79	56	28	41	14	12	665	508	105	46	6	51	614
	F	2	4	5	10	13	8	5	21	17	21	3	5	1	1	1	0	117	93	14	10	0	1	116
Sales/MFG Opium or Cocaine & Their Derivatives	M	21	15	31	35	26	27	14	108	59	57	46	31	25	7	2	0	504	249	236	15	4	45	459
	F	10	7	8	5	7	7	7	24	25	18	15	9	2	1	0	0	145	95	44	5	1	9	136
Sales/MFG Marijuana	M	65	55	49	58	55	52	38	120	66	70	73	49	14	10	2	1	777	543	186	43	5	45	732
	F	10	15	19	14	16	5	7	34	25	29	25	13	6	2	0	0	220	185	25	9	1	5	215
Sales/MFG Synthetic Narcotics	M	36	50	36	55	55	54	47	200	203	176	185	98	47	17	4	5	1,268	1,123	112	31	2	39	1,229
	F	15	18	19	19	18	19	19	85	84	89	60	29	13	2	1	2	492	452	14	25	1	9	483

OKLAHOMA STATE BUREAU OF INVESTIGATION

NUMBER OF ADULT ARRESTS STATE OF OKLAHOMA

2002

OFFENSE	SEX	AGE																TOTAL	RACE				ETHNICITY	
		18	19	20	21	22	23	24	25 - 29	30-34	35 - 39	40 - 44	45 - 49	50 - 54	55-59	60-64	65 and Over		WHITE	BLACK	INDIAN	ASIAN	Hispanic	Non Hispanic
Sales/MFG Other	M	14	12	18	13	13	25	20	69	78	71	75	35	12	3	3	3	464	340	112	10	2	19	445
	F	7	10	6	10	15	3	9	41	30	14	26	13	8	2	0	1	195	162	32	1	0	5	190
Possession Opium or Cocaine & Their Derivatives	M	102	116	104	110	96	105	78	388	307	327	296	206	94	32	9	4	2,374	1,318	977	60	19	255	2,119
	F	30	44	37	33	35	34	28	156	135	163	122	57	20	9	3	1	907	577	300	26	4	20	887
Possession Marijuana	M	694	727	602	581	459	381	328	1,019	666	570	533	269	126	51	20	6	7,032	5,392	1,313	310	17	300	6,732
	F	125	150	116	95	95	83	57	250	215	239	204	66	28	9	0	3	1,735	1,410	225	97	3	43	1,692
Possession Synthetic Narcotics	M	79	93	89	74	75	94	87	323	280	320	262	153	48	19	11	6	2,013	1,809	133	67	4	64	1,949
	F	23	28	39	24	32	37	24	113	149	157	109	41	19	7	7	1	810	750	28	29	3	10	800
Possession Other	M	49	50	55	38	49	38	36	164	132	112	144	80	31	13	3	1	995	817	141	33	4	28	967
	F	13	17	14	11	12	13	8	60	85	80	59	14	11	2	0	1	400	349	33	17	1	2	398
Bookmaking (Horse and Sport Book)	M	1	0	0	0	0	0	0	0	1	0	1	0	0	0	1	0	4	1	3	0	0	0	4
	F	0	1	0	0	1	0	0	1	0	1	0	0	1	0	0	0	5	2	3	0	0	0	5
Numbers and Lottery	M	0	0	0	0	0	0	0	1	0	0	0	0	0	0	0	0	1	1	0	0	0	1	0
	F	0	0	0	0	0	0	0	0	0	0	0	0	0	0	0	0	0	0	0	0	0	0	0
All Other Gambling	M	0	0	0	0	0	0	1	1	0	0	1	1	1	1	0	0	6	1	0	3	2	0	6
	F	0	0	0	0	0	0	0	0	1	0	2	2	0	0	0	0	5	3	1	0	1	0	5
Offenses Against Family and Children	M	14	27	16	28	32	23	22	152	157	146	131	78	42	10	8	6	892	715	106	69	2	46	846
	F	10	10	16	27	16	10	14	62	61	46	33	12	12	6	2	0	337	259	40	36	2	20	317
Driving Under The Influence	M	607	828	799	961	935	758	699	2,646	2,175	2,086	2,057	1,503	931	536	261	192	17,974	14,895	1,633	1,355	91	2,384	15,590
	F	100	151	141	199	149	137	116	446	518	572	622	327	137	54	23	21	3,713	2,913	291	490	19	109	3,604
Liquor Laws	M	291	279	244	98	86	78	46	189	140	128	128	76	55	35	12	16	1,901	1,545	158	167	31	151	1,750
	F	86	114	82	29	21	20	9	61	59	44	25	32	10	4	6	1	603	520	23	45	15	15	588

OKLAHOMA STATE BUREAU OF INVESTIGATION

NUMBER OF ADULT ARRESTS STATE OF OKLAHOMA

2002

OFFENSE	SEX	AGE																TOTAL	RACE				ETHNICITY	
		18	19	20	21	22	23	24	25 - 29	30-34	35 - 39	40 - 44	45 - 49	50 - 54	55-59	60-64	65 and Over		WHITE	BLACK	INDIAN	ASIAN	Hispanic	Non Hispanic
Drunkenness	M	878	952	856	1,072	954	799	678	2,299	2,101	2,335	2,705	1,867	1,093	639	294	192	19,714	13,650	2,055	3,938	71	1,757	17,957
	F	135	153	151	155	158	112	117	459	529	642	703	354	165	49	22	8	3,912	2,670	370	866	6	72	3,840
Disorderly Conduct	M	108	105	107	93	100	110	78	214	200	166	145	92	40	15	13	14	1,600	1,015	435	139	11	122	1,478
	F	26	38	40	31	28	35	23	70	77	67	70	30	16	9	3	6	569	327	183	55	4	21	548
All Other Offenses (Except Traffic)	M	1,332	1,572	1,553	1,383	1,341	1,216	1,048	4,116	3,534	3,213	2,891	1,748	811	413	163	143	26,477	18,531	5,955	1,833	158	1,239	25,238
	F	398	413	407	407	415	356	316	1,360	1,387	1,325	1,087	543	251	117	44	46	8,872	6,292	1,772	761	47	243	8,629

OKLAHOMA STATE BUREAU OF INVESTIGATION

**NUMBER OF ADULT ARRESTS
STATE OF OKLAHOMA**

2002

OFFENSE	SEX	AGE																TOTAL	RACE				ETHNICITY	
		18	19	20	21	22	23	24	25 - 29	30-34	35 - 39	40 - 44	45 - 49	50 - 54	55-59	60-64	65 and Over		WHITE	BLACK	INDIAN	ASIAN	Hispanic	Non Hispanic
SUBTOTALS FOR THE STATE OF OKLAHOMA																								
TOTAL SALES/MFG	M	136	132	134	161	149	158	119	497	406	374	379	213	98	37	11	9	3,013	2,255	646	99	13	148	2,865
	F	42	50	52	48	56	34	42	184	164	150	126	64	29	7	1	3	1,052	894	115	40	3	28	1,024
SALES TOTAL		178	182	186	209	205	192	161	681	570	524	505	277	127	44	12	12	4,065	3,149	761	139	16	176	3,889
TOTAL POSSESSION	M	924	986	850	803	679	618	529	1,894	1,385	1,329	1,235	708	299	115	43	17	12,414	9,336	2,564	470	44	647	11,767
	F	191	239	206	163	174	167	117	579	584	639	494	178	78	27	10	6	3,852	3,086	586	169	11	75	3,777
POSSESSION TOTAL		1,115	1,225	1,056	966	853	785	646	2,473	1,969	1,968	1,729	886	377	142	53	23	16,266	12,422	3,150	639	55	722	15,544
TOTAL DRUGS	M	1,060	1,118	984	964	828	776	648	2,391	1,791	1,703	1,614	921	397	152	54	26	15,427	11,591	3,210	569	57	795	14,632
	F	233	289	258	211	230	201	159	763	748	789	620	242	107	34	11	9	4,904	3,980	701	209	14	103	4,801
DRUG TOTAL		1,293	1,407	1,242	1,175	1,058	977	807	3,154	2,539	2,492	2,234	1,163	504	186	65	35	20,331	15,571	3,911	778	71	898	19,433
TOTAL GAMBLING	M	1	0	0	0	0	0	1	2	1	0	2	1	1	1	1	0	11	3	3	3	2	1	10
	F	0	1	0	0	1	0	0	1	1	1	2	2	1	0	0	0	10	5	4	0	1	0	10
TOTAL GAMBLING		1	1	0	0	1	0	1	3	2	1	4	3	2	1	1	0	21	8	7	3	3	1	20
TOTAL MALES		6,263	6,667	6,102	6,019	5,522	4,866	4,182	15,823	13,525	12,892	12,376	7,895	4,184	2,199	978	779	110,272	80,169	19,592	9,927	584	8,286	101,986
TOTAL FEMALES		1,594	1,773	1,597	1,484	1,426	1,284	1,080	4,637	4,743	4,699	4,128	2,056	943	409	154	146	32,153	23,237	5,646	3,097	173	920	31,233
GRAND TOTAL		7,857	8,440	7,699	7,503	6,948	6,150	5,262	20,460	18,268	17,591	16,504	9,951	5,127	2,608	1,132	925	142,425	103,406	25,238	13,024	757	9,206	133,219

OKLAHOMA STATE BUREAU OF INVESTIGATION

COUNTY ARRESTS BY CATEGORY

2002

COUNTY : Includes the county sheriff's department and all reporting agencies within that county.

INDEX CRIMES : Murder, Rape, Robbery, Aggravated Assault, Burglary, Larceny, and Motor Vehicle Theft. This category DOES NOT include Manslaughter and Other Assaults (not aggravated.)

DRUG RELATED : All drug arrests reported as Sale/Manufacturing and Possession.

ALCOHOL RELATED : The reported alcohol related offenses include Driving Under the Influence, Liquor Law Violations, and Drunkenness.

COUNTY	INDEX CRIMES		DRUG RELATED		ALCOHOL RELATED		TOTAL ARRESTS	
	JUVENILE	ADULT	JUVENILE	ADULT	JUVENILE	ADULT	JUVENILE	ADULT
ADAIR COUNTY	16	154	1	40	10	299	38	922
ALFALFA COUNTY	2	8	0	27	1	32	22	87
ATOKA COUNTY	29	96	6	133	6	205	73	595
BEAVER COUNTY	7	10	1	43	4	68	27	170
BECKHAM COUNTY	15	48	14	205	19	444	100	1,274
BLAINE COUNTY	6	25	1	49	2	205	18	467
BRYAN COUNTY	46	99	25	371	24	1,062	204	2,267
CADDO COUNTY	17	137	16	182	15	765	150	1,363
CANADIAN COUNTY	138	215	35	255	44	596	599	2,839
CARTER COUNTY	128	329	32	353	69	1,582	432	2,776
CHEROKEE COUNTY	35	154	5	143	19	1,507	97	2,339
CHOCTAW COUNTY	29	91	6	59	10	225	59	590
CIMARRON COUNTY	0	2	0	19	0	38	0	89
CLEVELAND COUNTY	257	421	142	908	189	2,209	1,869	5,711
COAL COUNTY	6	20	8	106	2	115	27	283
COMANCHE COUNTY	313	728	36	468	10	485	875	4,979
COTTON COUNTY	6	16	2	104	2	104	21	270
CRAIG COUNTY	21	36	12	152	9	208	67	602
CREEK COUNTY	80	282	16	307	67	1,134	521	2,821
CUSTER COUNTY	26	139	5	245	8	555	82	1,200
DELAWARE COUNTY	39	98	13	125	16	317	147	919
DEWEY COUNTY	0	9	2	30	0	84	6	252
ELLIS COUNTY	0	1	0	6	0	35	2	50
GARFIELD COUNTY	128	191	19	237	39	495	539	1,991

OKLAHOMA STATE BUREAU OF INVESTIGATION

COUNTY ARRESTS BY CATEGORY

2002

COUNTY	INDEX CRIMES		DRUG RELATED		ALCOHOL RELATED		TOTAL ARRESTS	
	JUVENILE	ADULT	JUVENILE	ADULT	JUVENILE	ADULT	JUVENILE	ADULT
GARVIN COUNTY	49	81	18	188	6	378	166	947
GRADY COUNTY	50	163	33	192	56	532	353	1,244
GRANT COUNTY	0	10	0	13	0	44	3	189
GREER COUNTY	1	4	1	30	3	44	8	110
HARMON COUNTY	2	2	3	12	6	58	22	126
HARPER COUNTY	2	7	0	21	0	13	8	84
HASKELL COUNTY	13	24	0	88	5	203	26	497
HUGHES COUNTY	19	45	6	80	3	258	64	540
JACKSON COUNTY	46	67	4	69	9	256	114	896
JEFFERSON COUNTY	20	29	0	40	2	62	26	215
JOHNSTON COUNTY	8	27	0	25	3	270	16	526
KAY COUNTY	251	300	27	183	65	1,138	1,035	2,100
KINGFISHER COUNTY	10	35	9	116	10	130	55	490
KIOWA COUNTY	17	46	6	45	4	124	81	556
LATIMER COUNTY	5	46	1	66	5	185	18	528
LEFLORE COUNTY	42	154	19	363	29	802	138	2,040
LINCOLN COUNTY	13	68	2	111	12	331	44	649
LOGAN COUNTY	29	93	23	165	3	177	107	659
LOVE COUNTY	15	21	0	53	1	214	22	399
MAJOR COUNTY	0	10	0	41	0	57	0	220
MARSHALL COUNTY	5	38	1	98	14	430	51	829
MAYES COUNTY	17	113	5	150	18	467	75	1,038
MCCLAIN COUNTY	22	70	13	260	30	406	266	1,171
MCCURTAIN COUNTY	28	163	15	219	26	677	135	1,381
MCINTOSH COUNTY	21	67	10	183	11	221	74	726
MURRAY COUNTY	24	38	4	108	9	191	70	500
MUSKOGEE COUNTY	106	387	27	537	47	946	516	4,149
NOBLE COUNTY	2	9	3	67	11	191	27	308
NOWATA COUNTY	22	21	0	33	0	95	49	330
OKFUSKEE COUNTY	15	95	7	43	27	392	205	960
OKLAHOMA COUNTY	1,678	3,955	568	4,782	354	8,042	5,830	30,681
OKMULGEE COUNTY	55	161	5	160	31	580	191	1,080
OSAGE COUNTY	11	64	2	152	25	335	63	935
OTTAWA COUNTY	64	110	3	226	19	716	210	1,916
PAWNEE COUNTY	8	45	4	152	5	260	26	804
PAYNE COUNTY	123	274	31	394	58	1,385	330	2,889
PITTSBURG COUNTY	81	235	9	285	54	739	257	2,149
PONTOTOC COUNTY	66	162	11	191	32	714	206	1,473

OKLAHOMA STATE BUREAU OF INVESTIGATION

COUNTY ARRESTS BY CATEGORY

2002

COUNTY	INDEX CRIMES		DRUG RELATED		ALCOHOL RELATED		TOTAL ARRESTS	
	JUVENILE	ADULT	JUVENILE	ADULT	JUVENILE	ADULT	JUVENILE	ADULT
POTTAWATOMIE COUNTY	77	245	13	163	35	847	296	2,280
PUSHMATAHA COUNTY	17	44	1	99	5	260	39	660
ROGER MILLS COUNTY	0	4	0	11	0	21	1	59
ROGERS COUNTY	73	151	14	301	25	653	145	1,829
SEMINOLE COUNTY	36	91	7	135	25	745	84	1,654
SEQUOYAH COUNTY	42	205	32	909	17	441	138	2,085
STEPHENS COUNTY	56	89	16	211	25	430	237	2,088
TEXAS COUNTY	14	49	12	154	19	545	90	1,031
TILLMAN COUNTY	15	27	5	37	3	78	120	247
TULSA COUNTY	2,082	4,147	348	3,180	256	7,633	5,183	24,416
WAGONER COUNTY	62	100	7	148	29	397	181	1,439
WASHINGTON COUNTY	120	233	28	257	23	403	285	1,863
WASHITA COUNTY	4	27	1	58	7	88	19	216
WOODS COUNTY	2	16	4	74	4	93	29	310
WOODWARD COUNTY	32	113	11	86	37	351	261	1,058
GRAND TOTAL	6,916	16,089	1,766	20,331	2,068	47,817	23,970	142,425

VI

LAW ENFORCEMENT

OFFICERS

KILLED or ASSAULTED

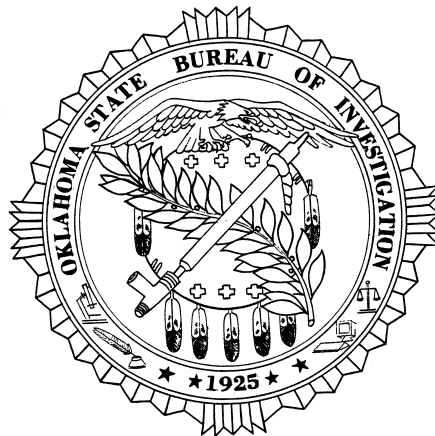

OKLAHOMA STATE BUREAU OF INVESTIGATION

OFFICERS KILLED OR ASSAULTED

The Oklahoma Uniform Crime Reporting Program requires the collection of statistical information relating to law enforcement officers killed in the line of duty and the number assaulted while on duty.

Zero (0) officers were killed in 2002 as the result of a felonious act.

Zero (0) officers were killed in 2002 as the result of an accident or negligent act.

A total of 843 assaults was reported on state, county, and municipal law enforcement officers in Oklahoma in 2002. This represents a 3.3% increase from the 2001 total.

OFFICER ASSIGNMENT INFORMATION

TYPE OF ASSIGNMENT		YEAR	NUMBER ASSAULTED	% CHANGE	% DISTRIBUTION
TWO MAN VEHICLE		2002	52	-21.2	6.2
		2001	66	-35.3	8.1
		2000	102	-43.3	12.1
ONE MAN VEHICLE	ALONE	2002	133	-22.2	15.8
		2001	171	-15.8	21.0
		2000	203	+6.8	24.0
	ASSISTED	2002	545	+15.7	64.7
		2001	471	+8.5	57.7
		2000	434	+33.5	51.4
DETECTIVE	ALONE	2002	8	-11.1	0.9
		2001	9	-40.0	1.1
		2000	15	-34.8	1.8
	ASSISTED	2002	21	0.0	2.5
		2001	21	+50.0	2.6
		2000	14	-64.1	1.7
OTHER	ALONE	2002	27	+28.6	3.2
		2001	21	-16.0	2.6
		2000	25	+56.3	3.0
	ASSISTED	2002	57	0.0	6.8
		2001	57	+9.6	7.0
		2000	52	-7.1	6.2
TOTAL		2002	843	+3.3	100.0
		2001	816	-3.4	100.0
		2000	845	+1.9	100.0

OKLAHOMA STATE BUREAU OF INVESTIGATION

OFFICER ASSAULTS BY ACTIVITY

CIRCUMSTANCES	YEAR	NUMBER ASSAULTED	% CHANGE	% DISTRIBUTION
DISTURBANCE CALL	2002	341	+12.2	40.5
	2001	304	+6.3	37.3
	2000	286	+2.1	33.8
BURGLARY IN PROGRESS	2002	10	-50.0	1.2
	2001	20	-13.0	2.5
	2000	23	+228.6	2.7
ROBBERY IN PROGRESS	2002	16	+100.0	1.9
	2001	8	+700.0	1.0
	2000	1	-80.0	0.1
ATTEMPTING OTHER ARREST	2002	97	+5.4	11.5
	2001	92	-5.2	11.3
	2000	97	+5.4	11.5
CIVIL DISORDER	2002	13	+18.2	1.5
	2001	11	+10.0	1.3
	2000	10	+150.0	1.2
HANDLING, TRANSPORTING PRISONER	2002	90	-26.2	10.7
	2001	122	-19.2	15.0
	2000	151	+9.4	17.9
INVESTIGATING SUSPICIOUS PERSON OR CIRCUMSTANCES	2002	66	+3.1	7.8
	2001	64	-29.7	7.8
	2000	91	+8.3	10.8
AMBUSH-NO WARNING	2002	9	0.0	1.1
	2001	9	0.0	1.1
	2000	9	+350.0	1.1
MENTALLY DERANGED	2002	16	+166.7	1.9
	2001	6	+50.0	0.7
	2000	4	-33.3	0.5
TRAFFIC PURSUITS AND STOPS	2002	114	-5.0	13.5
	2001	120	-4.0	14.7
	2000	125	-18.3	14.8
ALL OTHER	2002	71	+18.3	8.4
	2001	60	+25.0	7.4
	2000	48	-17.2	5.7
TOTAL	2002	843	+3.3	100.0
	2001	816	-3.4	100.0
	2000	845	+1.9	100.0

OKLAHOMA STATE BUREAU OF INVESTIGATION

OFFICER ASSAULTS BY TIME

TIME	YEAR	NUMBER ASSAULTED	% CHANGE	% DISTRIBUTION
12 A.M. - 2 A.M.	2002	121	+10.0	14.4
	2001	110	-19.1	13.5
	2000	136	+61.9	16.1
2 A.M. - 4 A.M.	2002	89	+43.5	10.6
	2001	62	-18.4	7.6
	2000	76	-3.8	9.0
4 A.M. - 6 A.M.	2002	28	-15.2	3.3
	2001	33	+22.2	4.0
	2000	27	+58.8	3.2
6 A.M. - 8 A.M.	2002	26	+160.0	3.1
	2001	10	-16.7	1.2
	2000	12	-20.0	1.4
8 A.M. - 10 A.M.	2002	30	+3.4	3.6
	2001	29	+45.0	3.6
	2000	20	-25.9	2.4
10 A.M. - 12 P.M.	2002	34	+13.3	4.0
	2001	30	-9.1	3.7
	2000	33	-15.4	3.9
12 P.M. - 2 P.M.	2002	49	+44.1	5.8
	2001	34	-2.9	4.2
	2000	35	-27.1	4.1
2 P.M. - 4 P.M.	2002	45	-4.3	5.3
	2001	47	-16.1	5.8
	2000	56	+43.6	6.6
4 P.M. - 6 P.M.	2002	65	-14.5	7.7
	2001	76	-13.6	9.3
	2000	88	-25.4	10.4
6 P.M. - 8 P.M.	2002	81	-22.1	9.6
	2001	104	-2.8	12.7
	2000	107	+13.8	12.7
8 P.M. - 10 P.M.	2002	109	-9.2	12.9
	2001	120	+6.2	14.7
	2000	113	-8.1	13.4
10 P.M. - 12 A.M.	2002	166	+3.1	19.7
	2001	161	+13.4	19.7
	2000	142	-2.7	16.8
TOTAL	2002	843	+3.3	100.0
	2001	816	-3.4	100.0
	2000	845	+1.9	100.0

OKLAHOMA STATE BUREAU OF INVESTIGATION

OFFICER ASSAULTS BY WEAPON

WEAPON	YEAR	NUMBER ASSAULTED	% CHANGE	% DISTRIBUTION
FIREARMS	2002	44	+18.9	5.2
	2001	37	-14.0	4.5
	2000	43	+16.2	5.1
KNIFE, CUTTING INSTRUMENT	2002	14	-17.6	1.7
	2001	17	-26.1	2.1
	2000	23	+21.1	2.7
OTHER DANGEROUS WEAPON	2002	132	+40.4	15.7
	2001	94	-11.3	11.5
	2000	106	-14.5	12.5
HANDS, FISTS, FEET, ETC.	2002	653	-2.2	77.5
	2001	668	-0.7	81.9
	2000	673	+3.7	79.6
TOTAL	2002	843	+3.3	100.0
	2001	816	-3.4	100.0
	2000	845	+1.9	100.0

OFFICER INJURY INFORMATION

INJURY	YEAR	NUMBER ASSAULTED	% CHANGE	% DISTRIBUTION
WITHOUT INJURY	2002	662	-1.0	78.5
	2001	669	-4.2	82.0
	2000	698	+1.3	82.6
WITH INJURY	2002	181	+23.1	21.5
	2001	147	0.0	18.0
	2000	147	+5.0	17.4
TOTAL	2002	843	+3.3	100.0
	2001	816	-3.4	100.0
	2000	845	+1.9	100.0

OKLAHOMA STATE BUREAU OF INVESTIGATION

LAW ENFORCEMENT EMPLOYEE DATA

Definition: Persons employed as full-time sworn officers and full-time civilian employees.

The figures below represent a compilation of forms sent to all reporting law enforcement agencies throughout the state on an annual basis.

With the exception of persons who perform guard or protection duties and who are not paid from police funds, i.e., school crossing guards, special officers, and merchant police, these figures reflect the number of full-time sworn personnel with full arrest power, including the chief, sheriff, commissioner, and superintendent. The figures do not include employees of the Oklahoma Highway Patrol, the Oklahoma State Bureau of Investigation, or those law enforcement agencies which do not contribute to the Uniform Crime Reporting Program.

Civilians include clerks, radio dispatchers, meter maids, stenographers, mechanics, etc., provided these persons are full-time employees of the agency. Neither employees who are compensated from a source other than police funds, nor those receiving salaries from federal grants are included. In 2002, Oklahoma's law enforcement rate was 2.6 employees per 1,000 inhabitants.

FULL-TIME LAW ENFORCEMENT AND CIVILIAN EMPLOYEES

	MALE	FEMALE	TOTAL
FULL-TIME SWORN LAW ENFORCEMENT OFFICERS	5,802	501	6,303
FULL-TIME CIVILIAN EMPLOYEES	1,184	1,703	2,887
TOTAL	6,986	2,204	9,190

VII
RURAL
CRIME



OKLAHOMA STATE BUREAU OF INVESTIGATION

RURAL INDEX CRIME OFFENSES

Rural Crime has been defined for this publication as all index crimes reported by the county sheriffs' departments in all 77 counties, exclusive of the cities and towns that report directly to the Oklahoma State Bureau of Investigation. *Due to a computer calculation error, the 2001 annual crime report for rural crimes in the category of murder was reported as 52. The current report reflects the correction for rural murder for 2001.*

RURAL VIOLENT CRIMES - A THREE-YEAR COMPARISON

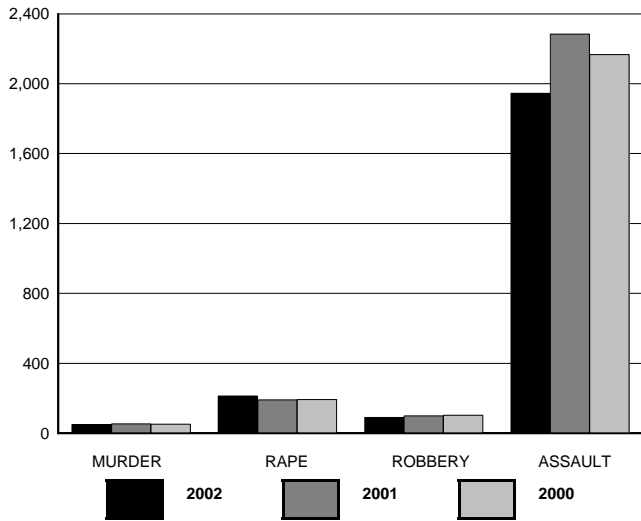

OFFENSE	2002	2001	2000
MURDER	49	54	51
RAPE	212	191	193
ROBBERY	90	100	102
ASSAULT	1,945	2,284	2,166
TOTAL	2,296	2,629	2,512

RURAL MURDER

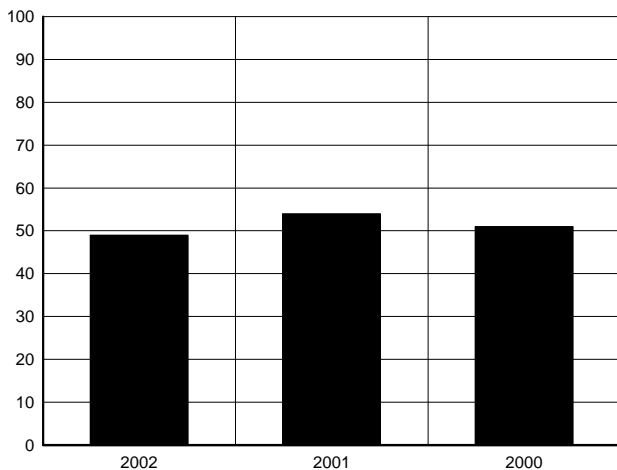

MURDER	2002	2001	2000
	49	54	51

RURAL RAPE

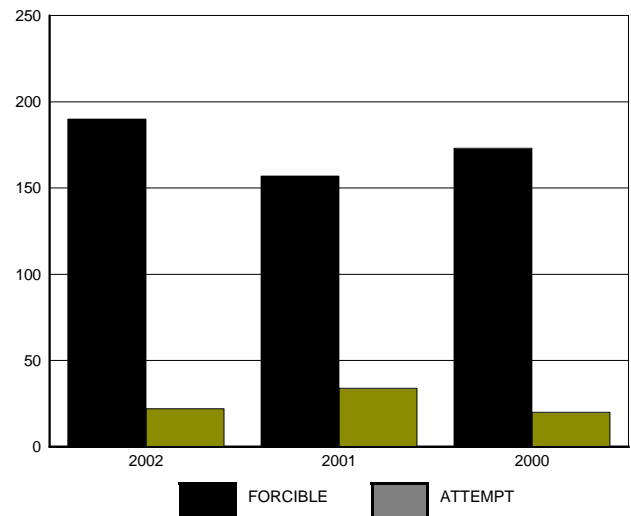

RAPE	2002	2001	2000
FORCIBLE	190	157	173
ATTEMPT	22	34	20

OKLAHOMA STATE BUREAU OF INVESTIGATION

RURAL ROBBERY BY WEAPON

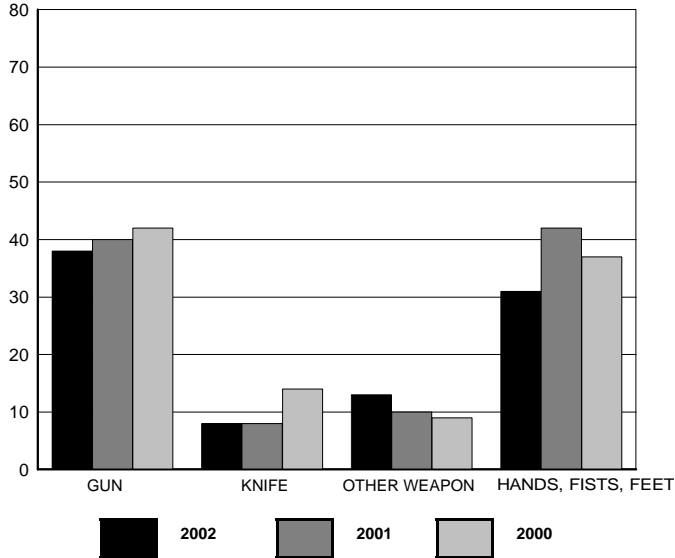

ROBBERY	2002	2001	2000
GUN	38	40	42
KNIFE	8	8	14
OTHER WEAPON	13	10	9
HANDS, FISTS, FEET	31	42	37
TOTAL	90	100	102

RURAL AGGRAVATED ASSAULT BY WEAPON

ASSAULT	2002	2001	2000
GUN	284	357	353
KNIFE	204	194	182
OTHER WEAPON	501	650	538
HANDS, FISTS, FEET	956	1,083	1,093
TOTAL	1,945	2,284	2,166

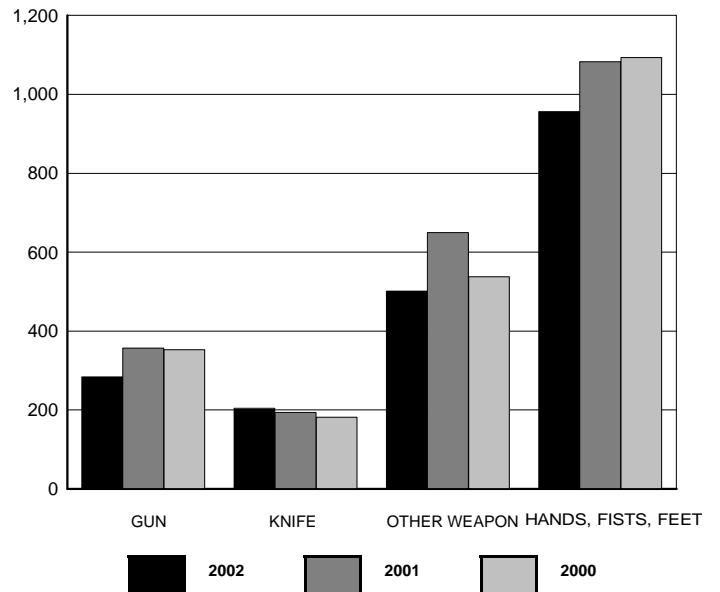

OKLAHOMA STATE BUREAU OF INVESTIGATION

RURAL NON-VIOLENT CRIMES (WITH ARSON) - A THREE-YEAR COMPARISON

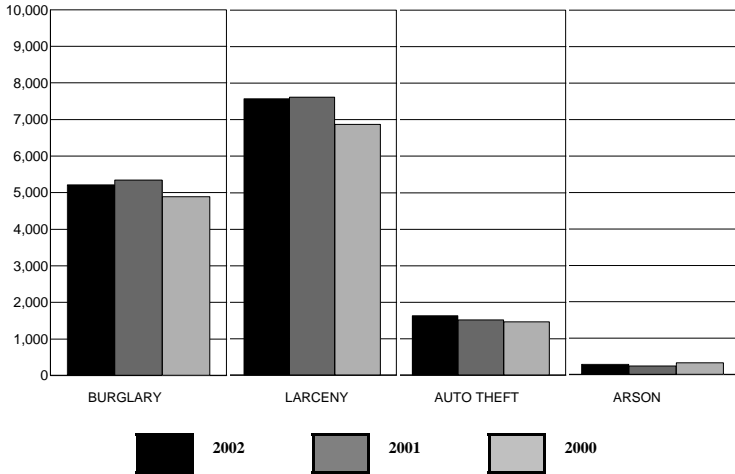

OFFENSE	2002	2001	2000
BURGLARY	5,213	5,342	4,887
LARCENY	7,574	7,613	6,876
AUTO THEFT	1,634	1,520	1,468
ARSON	284	240	332
TOTAL	14,705	14,715	13,563

RURAL PROPERTY STOLEN AND RECOVERED TYPE AND VALUE

CATEGORY	VALUE STOLEN	VALUE RECOVERED
Currency	1,118,108	28,269
Jewelry	1,715,386	63,264
Clothing	189,253	11,367
Vehicles	11,100,676	4,718,560
Office Equipment	361,484	7,901
TV, Radios, etc.	1,680,867	83,610
Firearms	940,561	63,417
Household Items	695,082	17,058
Consumable Goods	191,180	5,602
Livestock	916,719	121,554
Miscellaneous	12,840,546	1,163,885
TOTAL	31,749,862	6,284,487

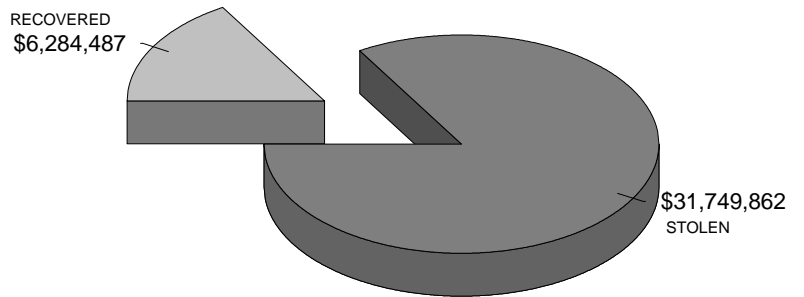

OKLAHOMA STATE BUREAU OF INVESTIGATION

RURAL BURGLARY BY TYPE

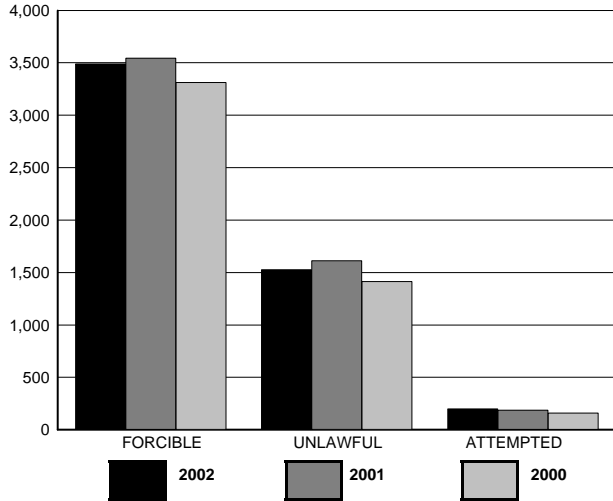

OFFENSE	2002	2001	2000
FORCIBLE	3,489	3,543	3,313
UNLAWFUL	1,526	1,613	1,414
ATTEMPTED	198	186	160
TOTAL	5,213	5,342	4,887

RURAL BURGLARY BY TIME OF DAY

RESIDENCE

NON-RESIDENCE

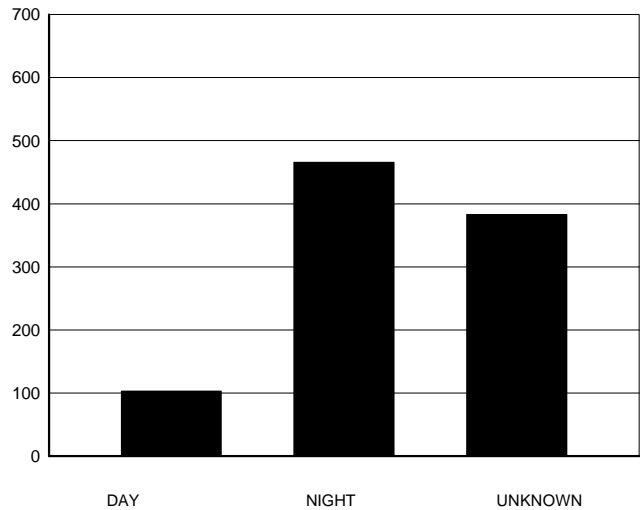
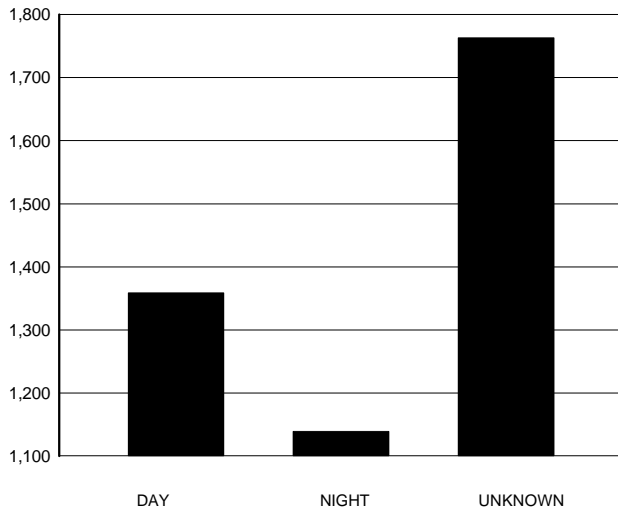

DAY	NIGHT	UNKNOWN
1,359	1,139	1,763

DAY	NIGHT	UNKNOWN
103	466	383

OKLAHOMA STATE BUREAU OF INVESTIGATION

RURAL LARCENY BY VALUE

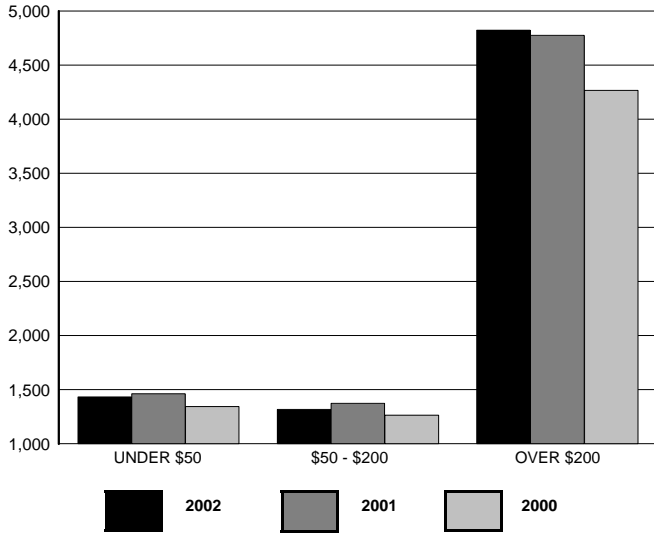

VALUE	2002	2001	2000
UNDER \$50	1,433	1,464	1,344
\$50 - \$200	1,319	1,375	1,266
OVER \$200	4,822	4,774	4,266
TOTAL	7,574	7,613	6,876

RURAL MOTOR VEHICLE THEFT BY TYPE

TYPE	2002	2001	2000
AUTOS	589	655	693
TRUCKS	534	493	488
OTHER	511	372	287
TOTAL	1,634	1,520	1,468

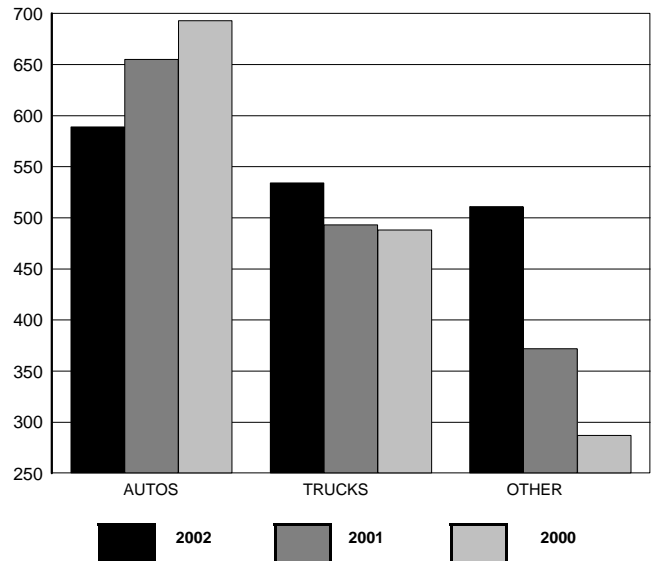

VIII

DOMESTIC ABUSE

AND

HATE/BIAS CRIME

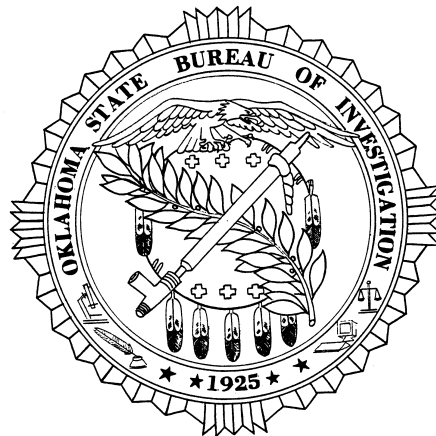

OKLAHOMA STATE BUREAU OF INVESTIGATION

DOMESTIC ABUSE

Definition: Threatening, causing or attempting to cause serious physical harm between family or household members.

Domestic Abuse includes such offenses as murder, sex crimes, assault, and assault and battery. Family or household members are defined as spouses, former spouses, present spouses of former spouses, parents, foster parents, children, persons otherwise related by blood or marriage, or living in the same household or who formerly lived in the same household. Also included in this category are persons in dating relationships (defined as courtships or engagement relationships) or someone with whom they had a child. It also includes the elderly and handicapped.

YEAR	TOTAL
1993	16,605
1994	18,153
1995	18,621
1996	21,683
1997	23,087
1998	21,435
1999	21,211
2000	22,065
2001	23,687
2002	25,157

ANALYSIS
MOST COMMON:
OFFENSE: ASSAULT & BATTERY
DAY OF WEEK: SUNDAY
TIME OF DAY: 2201 - 2300

Domestic abuse reports have increased by 51.5% between 1993 and 2002.

DOMESTIC ABUSE BY OFFENSE

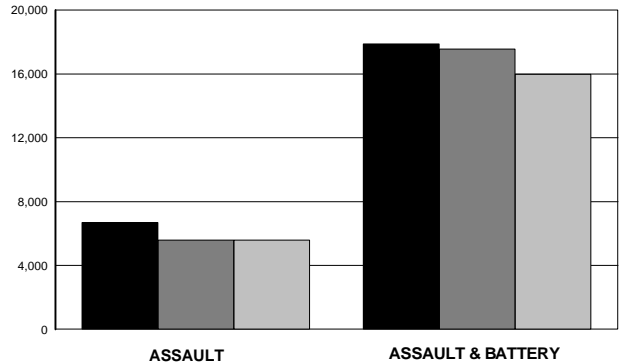
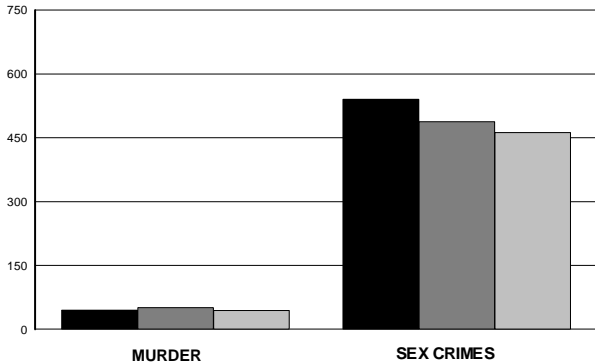

	MURDER	SEX CRIMES	ASSAULT	ASSAULT & BATTERY
2002	45	540	6,692	17,880
2001	51	488	5,595	17,553
2000	44	462	5,581	15,978

2002
 2001
 2000

OKLAHOMA STATE BUREAU OF INVESTIGATION

DOMESTIC ABUSE BY TIME OF DAY 2002

TIME OF DAY	MURDER	SEX CRIMES	ASSAULT	ASSAULT & BATTERY	TOTAL
0001 - 0100	7	41	374	1,097	1,519
0101 - 0200	1	8	270	739	1,018
0201 - 0300	1	5	239	695	940
0301 - 0400	2	12	144	454	612
0401 - 0500	2	7	112	332	453
0501 - 0600	2	6	66	238	312
0601 - 0700	0	9	71	282	362
0701 - 0800	2	5	115	326	448
0801 - 0900	0	20	115	392	527
0901 - 1000	0	26	187	470	683
1001 - 1100	2	24	208	555	789
1101 - 1200	1	21	216	648	886
1201 - 1300	3	30	264	696	993
1301 - 1400	1	50	251	723	1,025
1401 - 1500	1	42	270	726	1,039
1501 - 1600	2	39	323	808	1,172
1601 - 1700	2	28	351	962	1,343
1701 - 1800	3	35	405	1,014	1,457
1801 - 1900	3	29	416	1,067	1,515
1901 - 2000	0	24	425	1,086	1,535
2001 - 2100	2	22	477	1,140	1,641
2101 - 2200	3	20	469	1,239	1,731
2201 - 2300	2	30	505	1,234	1,771
2301 - 2400	3	7	419	957	1,386
TOTAL	45	540	6,692	17,880	25,157

OKLAHOMA STATE BUREAU OF INVESTIGATION

DOMESTIC ABUSE BY DAY OF WEEK

DAY OF WEEK	YEAR	MURDER	SEX CRIMES	ASSAULT	ASSAULT & BATTERY	TOTAL
SUNDAY	2002	8	66	1,203	3,001	4,278
	2001	10	64	937	2,971	3,982
	2000	6	51	920	2,674	3,651
MONDAY	2002	8	86	917	2,469	3,480
	2001	5	83	775	2,455	3,318
	2000	5	69	680	2,087	2,841
TUESDAY	2002	11	84	890	2,427	3,412
	2001	7	61	784	2,261	3,113
	2000	6	60	727	2,000	2,793
WEDNESDAY	2002	7	85	867	2,283	3,242
	2001	7	65	698	2,294	3,064
	2000	4	74	752	2,084	2,914
THURSDAY	2002	5	86	824	2,268	3,183
	2001	6	81	773	2,320	3,180
	2000	7	65	744	2,078	2,894
FRIDAY	2002	2	79	906	2,418	3,405
	2001	8	79	708	2,379	3,174
	2000	7	84	760	2,239	3,090
SATURDAY	2002	4	54	1,085	3,014	4,157
	2001	8	55	920	2,873	3,856
	2000	9	59	998	2,816	3,882
TOTAL	2002	45	540	6,692	17,880	25,157
	2001	51	488	5,595	17,553	23,687
	2000	44	462	5,581	15,978	22,065

DOMESTIC ABUSE BY OFFENSE

CLASSIFICATION	YEAR	NUMBER OF OFFENSES	% CHANGE	% DISTRIBUTION
MURDER	2002	45	-11.8	0.2
	2001	51	+15.9	0.2
	2000	44	-31.3	0.2
SEX CRIMES	2002	540	+10.7	2.1
	2001	488	+5.6	2.1
	2000	462	+43.5	2.1
ASSAULT	2002	6,692	+19.6	26.6
	2001	5,595	+0.3	23.6
	2000	5,581	+3.4	25.3
ASSAULT & BATTERY	2002	17,880	+1.9	71.1
	2001	17,553	+9.9	74.1
	2000	15,978	+3.6	72.4
TOTAL	2002	25,157	+6.2	100.0
	2001	23,687	+7.4	100.0
	2000	22,065	+4.0	100.0

OKLAHOMA STATE BUREAU OF INVESTIGATION

HATE/BIAS CRIMES

Definition: A criminal offense committed against a person or property, which is motivated by the offender's bias against race, religion, ethnic/national origin, sexual orientation, or disability.

The following tables do not reflect all categories of Hate/Bias Crimes, only those reported in 2002.

TYPE OF OFFENSE	NUMBER OF OFFENSES	NUMBER OF VICTIMS
AGGRAVATED ASSAULT	5	6
BURGLARY	2	2
SIMPLE ASSAULT	10	15
INTIMIDATION	14	18
VANDALISM	18	20
TOTAL	49	61

TYPE OF VICTIM	NUMBER BY INCIDENT
INDIVIDUAL	39
BUSINESS	3
RELIGIOUS ORGANIZATION	3
GOVERNMENT	2
SOCIETY	2
TOTAL	49

NUMBER OF OFFENDERS	NUMBER BY INCIDENT
ONE	20
TWO	5
THREE	4
TEN	2
UNKNOWN	18
TOTAL	49

LOCATION OF INCIDENT	NUMBER BY INCIDENT
CHURCH/SYNAGOGUE/TEMPLE	2
COMMERCIAL/OFFICE BUILDING	1
CONVENIENCE STORE	2
DRUG STORE/DR'S OFFICE/HOSPITAL	1
GOVERNMENT/PUBLIC BUILDING	2
HIGHWAY/ROAD/ALLEY/STREET	12
JAIL/PRISON	1
PARKING LOT/GARAGE	5
RESIDENCE/HOME	14
RESTAURANT	6
SCHOOL/COLLEGE	3
TOTAL	49

MOTIVATION ANTI-	NUMBER BY INCIDENT
BLACK	24
AMERICAN INDIAN/ALASKAN NATIVE	4
ASIAN/PACIFIC ISLANDER	2
MULTI-RELIGIOUS	1
HISPANIC	2
OTHER ETHNICITY	10
JEWISH	1
CATHOLIC	2
PROTESTANT	2
FEMALE HOMOSEXUAL	1
TOTAL	49

RACE OF OFFENDERS	NUMBER BY INCIDENT
WHITE	28
INDIAN	3
UNKNOWN	18
TOTAL	49

ANALYSIS	
MOST COMMON	
OFFENSE:	VANDALISM
TYPE OF VICTIM:	INDIVIDUAL
LOCATION:	RESIDENCE
MOTIVATION:	ANTI-BLACK
RACE OF OFFENDER:	WHITE

IX
INDEX CRIME
OFFENSES
BY
CONTRIBUTOR

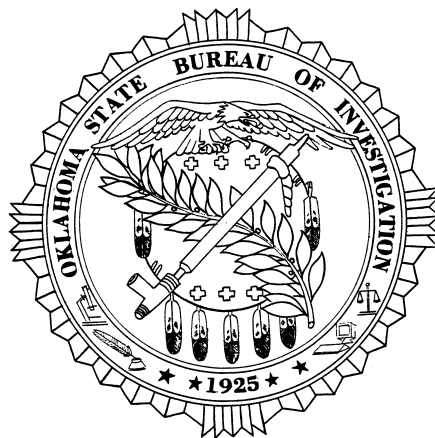

OKLAHOMA STATE BUREAU OF INVESTIGATION

CONTRIBUTORS

The following section sets forth a specific breakdown of index crime offenses by each contributing law enforcement agency for the years 2000, 2001, and 2002.

It must be remembered that the total index crime offenses reported are shown here, and the statistics include each month an agency reported. It should be noted that all agencies submitted reports in full for each year.

As is apparent, the delinquency of reports greatly hampers the Oklahoma Uniform Crime Reporting Program. In some states, crime trend data is only computed for those agencies that have a complete reporting record for the year or years. Others use estimated data for those agencies that did not submit reports for each month. The Oklahoma Uniform Crime Reporting Program employs the total number of offenses reported in its analysis as part of a continuing endeavor to provide complete crime statistics for the State of Oklahoma.

NOTE: The section is listed in alphabetical order by county and then in numerical order by the Originating Agency Identifier (ORI) assigned to reporting agencies within each county by the Federal Bureau of Investigation.

An alphabetical listing of all reporting agencies has been included in this publication; these agencies also have been cross-referenced to their respective counties.

It is our hope this will assist our users in locating specific agencies if the county is unknown.

POPULATION FIGURES

The population figures in this publication are used by the authority of the Federal Bureau of Investigation. Some communities have more growth than the average used by the FBI each year since a census is only taken each decade. This can have an influence on the crime rate per 1,000 population as shown in this section.

OKLAHOMA STATE BUREAU OF INVESTIGATION

ALPHABETICAL AGENCY LISTING

CITY	COUNTY
Ada	PONTOTOC
Agra	LINCOLN
Altus	JACKSON
Ava	WOODS
Anadarko	CADDO
Antlers	PUSHMATAHA
Apache	CADDO
Ardmore	CARTER
Arkoma	LEFLORE
Atoka	ATOKA
Barnsdall	OSAGE
Bartlesville	WASHINGTON
Beaver	BEAVER
Beggs	OKMULGEE
Bethany	OKLAHOMA
Bixby	TULSA
Blackwell	KAY
Blanchard	MCCLAIN
Boise City	CIMARRON
Bokoshe	LEFLORE
Bristow	CREEK
Broken Arrow	TULSA
Broken Bow	MCCURTAIN
Buffalo	HARPER
Caddo	BRYAN
Calera	BRYAN
Cameron University	COMANCHE
Capitol Patrol	OKLAHOMA

CITY	COUNTY
Carnegie	CADDO
Catoosa	ROGERS
Chandler	LINCOLN
Checotah	MCINTOSH
Chelsea	ROGERS
Cherokee	ALFALFA
Chickasha	GRADY
Choctaw	OKLAHOMA
Chouteau	MAYES
Claremore	ROGERS
Clayton	PUSHMATAHA
Cleveland	PAWNEE
Clinton	CUSTER
Coalgate	COAL
Colbert	BRYAN
Collinsville	TULSA
Comanche	STEPHENS
Commerce	OTTAWA
Cordell	WASHITA
Coweta	WAGONER
Crescent	LOGAN
Cushing	PAYNE
Davis	MURRAY
Del City	OKLAHOMA
Dewey	WASHINGTON
Dibble	MCCLAIN
Drumright	CREEK
Duncan	STEPHENS

CITY	COUNTY
Durant	BRYAN
East Central University Police Dept.	PONTOTOC
Edmond	OKLAHOMA
El Reno	CANADIAN
Elk City	BECKHAM
Elmore City	GARVIN
Enid	GARFIELD
Erick	BECKHAM
Eufaula	MCINTOSH
Fairfax	OSAGE
Fairview	MAJOR
Fletcher	COMANCHE
Forest Park	OKLAHOMA
Fort Gibson	MUSKOGEE
Frederick	TILLMAN
Geary	BLAINE
Glenpool	TULSA
Goodwell	TEXAS
Granite	GREER
Grove	DELAWARE
Guthrie	LOGAN
Guymon	TEXAS
Haileyville	PITTSBURG
Harrah	OKLAHOMA
Hartshorne	PITTSBURG
Haskell	MUSKOGEE
Heraldton	CARTER
Heavener	LEFLORE

OKLAHOMA STATE BUREAU OF INVESTIGATION

CITY	COUNTY
Hennessey	KINGFISHER
Henryetta	OKMULGEE
Hinton	CADDO
Hobart	KIOWA
Holdenville	HUGHES
Hollis	HARMON
Hominy	OSAGE
Hooker	TEXAS
Howe	LEFLORE
Hugo	CHOCTAW
Hulbert	CHEROKEE
Hydro	CADDO
Idabel	MCCURTAIN
Inola	ROGERS
Jay	DELAWARE
Jenks	TULSA
Jones	OKLAHOMA
Kingfisher	KINGFISHER
Kingston	MARSHALL
Konawa	SEMINOLE
Krebs	PITTSBURG
Laverne	HARPER
Lawton	COMANCHE
Lexington	CLEVELAND
Lindsay	GARVIN
Locust Grove	MAYES
Lone Grove	CARTER
Luther	OKLAHOMA

CITY	COUNTY
Madill	MARSHALL
Mangum	GREER
Mannford	CREEK
Marietta	LOVE
Marlow	STEPHENS
Maysville	GARVIN
McAlester	PITTSBURG
McLoud	POTTAWATOMIE
Meeker	LINCOLN
Miami	OTTAWA
Midwest City	OKLAHOMA
Minco	GRADY
Moore	CLEVELAND
Mooreland	WOODWARD
Morris	OKMULGEE
Mountain View	KIOWA
Muldrow	SEQUOYAH
Murray State College	JOHNSTON
Muskogee	MUSKOGEE
Mustang	CANADIAN
NE Oklahoma A&M College	OTTAWA
NE State University	CHEROKEE
Newcastle	MCCLAIN
Newkirk	KAY
Nichols Hills	OKLAHOMA
Nicom Park	OKLAHOMA
Ninnekah	GRADY
Noble	CLEVELAND

CITY	COUNTY
Norman	CLEVELAND
Norman Public Schools	CLEVELAND
Nowata	NOWATA
Olton	CREEK
Okeene	BLAINE
Okemah	OKFUSKEE
Okla State Univ/Okmulgee	OKMULGEE
Okla State Univ/Tulsa	TULSA
Okla Univ Health Sciences Center	OKLAHOMA
Oklahoma City	OKLAHOMA
Oklahoma State University	PAYNE
Okmulgee	OKMULGEE
Oologah	ROGERS
Owasso	TULSA
Pauls Valley	GARVIN
Pawhuska	OSAGE
Pawnee	PAWNEE
Perkins	PAYNE
Perry	NOBLE
Piedmont	CANADIAN
Pocola	LEFLORE
Ponca City	KAY
Porum	MUSKOGEE
Poteau	LEFLORE
Prague	LINCOLN
Pryor	MAYES
Purcell	MCCLAIN
Putnam City Campus	OKLAHOMA

OKLAHOMA STATE BUREAU OF INVESTIGATION

CITY	COUNTY
Ringling	JEFFERSON
Rogers State University	ROGERS
Roland	SEQUOYAH
Rush Springs	GRADY
SE OSU	BRYAN
SW OSU	CUSTER
Sallisaw	SEQUOYAH
Sand Springs	TULSA
Sapulpa	CREEK
Sayre	BECKHAM
Seiling	DEWEY
Seminole	SEMINOLE
Seminole State College	SEMINOLE
Shawnee	POTTAWATOMIE
Skiatook	TULSA
Snyder	KIOWA
Spencer	OKLAHOMA
Spiro	LEFLORE
Stigler	HASKELL
Stillwater	PAYNE
Stilwell	ADAIR
Stratford	GARVIN
Stringtown	ATOKA
Stroud	LINCOLN
Sulphur	MURRAY
Tahlequah	CHEROKEE
Talihina	LEFLORE
Tecumseh	POTTAWATOMIE

CITY	COUNTY
Temple	COTTON
Tishomingo	JOHNSTON
Tonkawa	KAY
Tulsa Community College	TULSA
Tulsa	TULSA
Tushka	ATOKA
Tuttle	GRADY
University of Central Oklahoma	OKLAHOMA
University of Oklahoma	CLEVELAND
Valliant	MCCURTAIN
Vian	SEQUOYAH
Village	OKLAHOMA
Vinita	CRAIG
Wagoner	WAGONER
Walters	COTTON
Warner	MUSKOGEE
Warr Acres	OKLAHOMA
Watonga	BLAINE
Waukomis	GARFIELD
Waurika	JEFFERSON
Waynoka	WOODS
Weatherford	CUSTER
Weleetka	OKFUSKEE
Westville	ADAIR
Wetumka	HUGHES
Wewoka	SEMINOLE
Wilburton	LATIMER
Wilson	CARTER

CITY	COUNTY
Woodward	WOODWARD
Wright City	MCCURTAIN
Wynnewood	GARVIN
Yale	PAYNE
Yukon	CANADIAN

OKLAHOMA STATE BUREAU OF INVESTIGATION

AGENCY	YEAR	POPULATION	TOTAL CRIME INDEX	CRIME RATE PER 1000	MURDER	RAPE	ROBBERY	FELONIOUS ASSAULT	BREAKING & ENTERING	LARCENY	MOTOR VEHICLE THEFT	ARSON
Adair County Sheriff's Office 00100	2002	16,367	339	20.71	2		1	63	125	106	42	12
	2001	16,166	338	20.91	2	1	1	122	111	69	32	7
	2000	16,040	288	17.96	3	4		92	111	43	35	5
Stilwell Police Department 00101	2002	3,317	277	83.51		2	2	54	52	143	24	1
	2001	3,276	282	86.08		1		40	65	165	11	2
	2000	3,470	203	58.50	1	5	1	13	40	122	21	8
Westville Police Department 00102	2002	1,616	95	58.79					26	65	4	
	2001	1,596	51	31.95					16	34	1	
	2000	1,601	74	46.22					19	53	2	
ADAIR COUNTY	2002	21,300	711	33.38	2	2	3	117	203	314	70	13
	2001	21,038	671	31.89	2	2	1	162	192	268	44	9
	2000	21,111	565	26.76	4	9	1	105	170	218	58	13
Alfalfa County Sheriff's Office 00200	2002	4,531	47	10.37		1		2	18	26		
	2001	4,475	40	8.94		1	1	1	10	18	9	
	2000	4,523	52	11.50				1	21	27	3	
Cherokee Police Department 00201	2002	1,650	20	12.12				6	10	4		
	2001	1,630	21	12.88				7	11		3	
	2000	1,526	24	15.73				4	12	8		
ALFALFA COUNTY	2002	6,181	67	10.84		1		8	28	30		
	2001	6,105	61	9.99		1	1	8	21	18	12	
	2000	6,049	76	12.56				5	33	35	3	
Atoka County Sheriff's Office 00300	2002	10,277	184	17.90		1		42	46	77	18	3
	2001	10,150	159	15.67		2	1	18	67	68	3	2
	2000	9,591	126	13.14	1	2		11	42	55	15	3
Atoka Police Department 00301	2002	3,025	236	78.02			2	36	66	123	9	1
	2001	2,988	127	42.50			5	23	22	72	5	6
	2000	3,435	147	42.79	1	1	5	24	28	81	7	2

OKLAHOMA STATE BUREAU OF INVESTIGATION

AGENCY	YEAR	POPULATION	TOTAL CRIME INDEX	CRIME RATE PER 1000	MURDER	RAPE	ROBBERY	FELONIOUS ASSAULT	BREAKING & ENTERING	LARCENY	MOTOR VEHICLE THEFT	ARSON
Stringtown Police Department 00308	2002	401	11	27.43				3	3	4	1	
	2001	396	11	27.78				2	3	4	2	1
	2000	389	9	23.14					3	5	1	
Tushka Police Department 00309	2002	349	14	40.11		1			4	8	1	
	2001	345	12	34.78				3	2	6	1	
	2000	333	13	39.04					4	9		
ATOKA COUNTY	2002	14,052	445	31.67		2	2	81	119	212	29	4
	2001	13,879	309	22.26		2	6	46	94	150	11	9
	2000	13,748	295	21.46	2	3	5	35	77	150	23	5
Beaver County Sheriff's Office 00400	2002	4,340	91	20.97	1		1	4	21	62	2	
	2001	5,857	148	25.27		4	2	1	32	102	7	1
	2000	6,182	97	15.69		2		2	36	49	8	
Beaver Police Department 00402	2002	1,590	35	22.01				2	6	25	2	1
	2001	Reported Through the County SO										
	2000	Reported Through the County SO										
BEAVER COUNTY	2002	5,930	126	21.25	1		1	6	27	87	4	1
	2001	5,857	148	25.27		4	2	1	32	102	7	1
	2000	6,182	97	15.69		2		2	36	49	8	
Beckham County Sheriff's Office 00500	2002	4,202	88	20.94		2		5	32	44	5	
	2001	4,152	95	22.88		2		15	23	45	10	2
	2000	4,613	97	21.03	3		1	13	34	32	14	1
Elk City Police Department 00501	2002	10,642	274	25.75		1	1	4	26	231	11	1
	2001	10,510	302	28.73		1	1	6	52	238	4	
	2000	11,429	403	35.26			1	10	58	320	14	1
Erick Police Department 00502	2002	1,036	24	23.17					11	11	2	
	2001	1,023	29	28.35				2	7	20		
	2000	1,157	40	34.57					7	33		

OKLAHOMA STATE BUREAU OF INVESTIGATION

AGENCY	YEAR	POPULATION	TOTAL CRIME INDEX	CRIME RATE PER 1000	MURDER	RAPE	ROBBERY	FELONIOUS ASSAULT	BREAKING & ENTERING	LARCENY	MOTOR VEHICLE THEFT	ARSON
Sayre Police Department 00503	2002	4,166	66	15.84				4	14	40	8	2
	2001	4,114	111	26.98		2	1	7	21	70	10	2
	2000	3,146	75	23.84				10	22	39	4	1
BECKHAM COUNTY	2002	20,046	452	22.55		3	1	13	83	326	26	3
	2001	19,799	537	27.12		5	2	30	103	373	24	4
	2000	20,345	615	30.23	3		2	33	121	424	32	3
Blaine County Sheriff's Office 00600	2002	4,725	89	18.84		2		6	24	49	8	12
	2001	4,668	71	15.21				11	24	31	5	1
	2000	5,019	82	16.34		2		13	21	38	8	2
Watonga Police Department 00601	2002	4,717	72	15.26			1	2	14	51	4	1
	2001	4,658	70	15.03				5	17	44	4	
	2000	3,092	103	33.31				17	29	53	4	
Geary Police Department 00605	2002	1,274	52	40.82		1		2	10	28	11	2
	2001	1,258	23	18.28		5		2	5	10	1	1
	2000	1,187	31	26.12		2		13	2	12	2	
Okeene Police Department 00610	2002	1,256	14	11.15					6	6	2	
	2001	1,240	22	17.74					10	12		
	2000	1,197	20	16.71				6	11	3		
BLAINE COUNTY	2002	11,972	227	18.96		3	1	10	54	134	25	15
	2001	11,824	186	15.73		5		18	56	97	10	2
	2000	10,495	236	22.49		4		49	63	106	14	2
Bryan County Sheriff's Office 00700	2002	19,477	314	16.12	3	1	3	22	116	116	53	3
	2001	19,237	354	18.40	2	5	5	52	121	137	32	21
	2000	18,412	364	19.77	1	12	3	51	130	129	38	11
Durant Police Department 00701	2002	13,718	940	68.52	1	15	6	41	204	611	62	4
	2001	13,549	836	61.70		5	9	21	177	548	76	1
	2000	13,350	679	50.86		3	3	24	165	427	57	

OKLAHOMA STATE BUREAU OF INVESTIGATION

AGENCY	YEAR	POPULATION	TOTAL CRIME INDEX	CRIME RATE PER 1000	MURDER	RAPE	ROBBERY	FELONIOUS ASSAULT	BREAKING & ENTERING	LARCENY	MOTOR VEHICLE THEFT	ARSON
Caddo Police Department 00709	2002	956	17	17.78				1	6	10		
	2001	944	15	15.89				6	1	7	1	
	2000	1,061	22	20.74				5	2	14	1	
Calera Police Department 00710	2002	1,761	64	36.34		4		11	9	37	3	1
	2001	1,739	67	38.53		4		8	16	34	5	
	2000	1,821	73	40.09		1		7	24	35	6	
Colbert Police Department 00713	2002	1,078	19	17.63				5	5	7	2	
	2001	1,065	19	17.84			1	2	6	7	3	
	2000	1,261	18	14.27				1	9	7	1	
SE OSU Police * 00726	2002	4,550	39	8.57		2		5	3	29		
	2001	4,456	43	9.65				7	15	20	1	
	2000	4,015	41	10.21		2			13	24	2	
BRYAN COUNTY	2002	36,990	1,393	37.66	4	22	9	85	343	810	120	8
	2001	36,534	1,334	36.51	2	14	15	96	336	753	118	22
	2000	35,905	1,197	33.34	1	18	6	88	343	636	105	11
Caddo County Sheriff's Office 00800	2002	17,529	350	19.97	2	1	2	67	102	140	36	8
	2001	17,311	231	13.34		2	2	34	53	119	21	3
	2000	19,258	169	8.78		4	1	10	54	78	22	12
Anadarko Police Department 00801	2002	6,727	323	48.02		4	1	42	70	183	23	26
	2001	6,645	326	49.06			3	26	76	204	17	26
	2000	6,947	292	42.03	2	2	1	28	62	181	16	18
Apache Police Department 00804	2002	1,636	56	34.23		1		4	15	27	9	
	2001	1,616	82	50.74		2		8	16	47	9	
	2000	1,501	71	47.30		1		2	7	57	4	1
Carnegie Police Department 00808	2002	1,657	48	28.97				5	19	22	2	1
	2001	1,637	82	50.09	1	1		6	30	39	5	1
	2000	1,787	57	31.90				8	29	19	1	

OKLAHOMA STATE BUREAU OF INVESTIGATION

AGENCY	YEAR	POPULATION	TOTAL CRIME INDEX	CRIME RATE PER 1000	MURDER	RAPE	ROBBERY	FELONIOUS ASSAULT	BREAKING & ENTERING	LARCENY	MOTOR VEHICLE THEFT	ARSON
Hinton Police Department 00815	2002	2,202	50	22.71		1		11	17	20	1	
	2001	2,175	65	29.89		1		15	10	37	2	
	2000	1,289	61	47.32				16	11	28	6	
Hydro Police Department 00816	2002	1,073	15	13.98					5	10		
	2001	1,060	14	13.21		1		1	3	9		
	2000	915	33	36.07				3	25	5		
CADDO COUNTY	2002	30,824	842	27.32	2	7	3	129	228	402	71	35
	2001	30,444	800	26.28	1	7	5	90	188	455	54	30
	2000	31,697	683	21.55	2	7	2	67	188	368	49	31
Canadian County Sheriff's Office 00900	2002	7,273	103	14.16		1		10	30	50	12	2
	2001	7,183	103	14.34			1	4	33	51	14	3
	2000	6,318	118	18.68		1		4	37	70	6	2
El Reno Police Department 00901	2002	16,414	594	36.19	1	4	9	46	109	380	45	2
	2001	16,212	673	41.51	1	9	7	68	112	442	34	6
	2000	16,426	645	39.27	2	5	15	68	130	376	49	1
Yukon Police Department 00902	2002	21,305	653	30.65	1	1	3	19	118	486	25	3
	2001	21,043	627	29.80	1	4	3	7	111	471	30	9
	2000	23,384	640	27.37		6	4	21	83	498	28	2
Mustang Police Department 00905	2002	13,320	454	34.08	2		2	37	63	332	18	
	2001	13,156	347	26.38		2	3	23	65	244	10	2
	2000	13,241	311	23.49		1	4	37	46	216	7	2
Piedmont Police Department 00906	2002	3,696	39	10.55		1		5	12	18	3	
	2001	3,650	48	13.15		1	1	5	21	17	3	
	2000	3,632	67	18.45		1	1	9	12	40	4	2
CANADIAN COUNTY	2002	62,008	1,843	29.72	4	7	14	117	332	1,266	103	7
	2001	61,244	1,798	29.36	2	16	15	107	342	1,225	91	20
	2000	63,001	1,781	28.27	2	14	24	139	308	1,200	94	9

OKLAHOMA STATE BUREAU OF INVESTIGATION

AGENCY	YEAR	POPULATION	TOTAL CRIME INDEX	CRIME RATE PER 1000	MURDER	RAPE	ROBBERY	FELONIOUS ASSAULT	BREAKING & ENTERING	LARCENY	MOTOR VEHICLE THEFT	ARSON
Carter County Sheriff's Office 01000	2002	13,071	229	17.52		8		44	71	96	10	3
	2001	12,909	225	17.43	1	4		25	61	122	12	5
	2000	11,713	189	16.14		3	2	18	48	101	17	2
Ardmore Police Department 01001	2002	24,007	1,977	82.35	2	9	26	252	325	1,301	62	7
	2001	23,711	1,750	73.81	2	8	22	226	303	1,122	67	9
	2000	24,760	1,858	75.04	2	7	12	205	373	1,182	77	16
Healdton Police Department 01010	2002	2,820	36	12.77				7	12	16	1	
	2001	2,786	38	13.64				2	13	18	5	2
	2000	3,031	47	15.51				7	12	21	7	2
Lone Grove Police Department 01011	2002	4,688	199	42.45			2	54	34	103	6	1
	2001	4,631	105	22.67		1	2	8	29	64	1	
	2000	4,557	130	28.53			2	19	31	74	4	1
Wilson Police Department 01017	2002	1,604	22	13.72				9	8	3	2	1
	2001	1,584	18	11.36					4	13	1	
	2000	1,700	57	33.53		1		7	17	29	3	2
CARTER COUNTY	2002	46,190	2,463	53.32	2	17	28	366	450	1,519	81	12
	2001	45,621	2,136	46.82	3	13	24	261	410	1,339	86	16
	2000	45,761	2,281	49.85	2	11	16	256	481	1,407	108	23
Cherokee County Sheriff's Office 01100	2002	27,855	339	12.17	1	2	1	68	122	117	28	4
	2001	27,520	329	11.95	3	5	1	106	97	85	32	1
	2000	26,489	431	16.27	1	2	2	148	134	112	32	1
Tahlequah Police Department 01101	2002	14,638	650	44.40	1	8	8	36	137	422	38	2
	2001	14,458	671	46.41		6	6	22	170	415	52	
	2000	13,371	692	51.75		11	4	23	149	459	46	
Hulbert Police Department 01105	2002	550	26	47.27				4	12	9	1	1
	2001	543	25	46.04				3	12	7	3	
	2000	736	13	17.66				2	8	3		

OKLAHOMA STATE BUREAU OF INVESTIGATION

AGENCY	YEAR	POPULATION	TOTAL CRIME INDEX	CRIME RATE PER 1000	MURDER	RAPE	ROBBERY	FELONIOUS ASSAULT	BREAKING & ENTERING	LARCENY	MOTOR VEHICLE THEFT	ARSON
NE State University Police * 01110	2002	10,214	66	6.46			1	2	13	49	1	1
	2001	9,795	104	10.62		2		2	31	65	4	
	2000	8,378	76	9.07				8	13	53	2	1
CHEROKEE COUNTY	2002	43,043	1,081	25.11	2	10	10	110	284	597	68	8
	2001	42,521	1,129	26.55	3	13	7	133	310	572	91	1
	2000	40,596	1,212	29.86	1	13	6	181	304	627	80	2
Choctaw County Sheriff's Office 01200	2002	9,928	195	19.64	1	2	1	37	58	76	20	1
	2001	9,806	154	15.70	2	1	1	42	49	51	8	2
	2000	9,380	165	17.59		1	3	43	75	38	5	14
Hugo Police Department 01201	2002	5,605	319	56.91	2	1	3	47	63	189	14	3
	2001	5,536	313	56.54	1	3	2	56	95	151	5	4
	2000	6,059	311	51.33		1	4	58	90	148	10	1
CHOCTAW COUNTY	2002	15,533	514	33.09	3	3	4	84	121	265	34	4
	2001	15,342	467	30.44	3	4	3	98	144	202	13	6
	2000	15,439	476	30.83		2	7	101	165	186	15	15
Cimarron County Sheriff's Office 01300	2002	1,686	12	7.12					5	7		
	2001	1,665	12	7.21				2	2	8		
	2000	1,621	7	4.32		1		2	2	2		1
Boise City Police Department 01301	2002	1,501	9	6.00				3	2	2	2	
	2001	1,483	5	3.37				1		3	1	
	2000	1,382	10	7.24				4	1	4	1	
CIMARRON COUNTY	2002	3,187	21	6.59				3	7	9	2	
	2001	3,148	17	5.40				3	2	11	1	
	2000	3,003	17	5.66		1		6	3	6	1	1
Cleveland County Sheriff's Office 01400	2002	16,773	354	21.11		20	1	37	128	150	18	5
	2001	16,567	462	27.89	1	1		67	169	192	32	5
	2000	14,683	408	27.79		7	2	58	152	159	30	5

OKLAHOMA STATE BUREAU OF INVESTIGATION

AGENCY	YEAR	POPULATION	TOTAL CRIME INDEX	CRIME RATE PER 1000	MURDER	RAPE	ROBBERY	FELONIOUS ASSAULT	BREAKING & ENTERING	LARCENY	MOTOR VEHICLE THEFT	ARSON
Moore Police Department 01401	2002	41,652	1,729	41.51		17	14	104	332	1,138	124	7
	2001	41,138	1,718	41.76	1	31	21	204	321	956	184	7
	2000	46,684	1,668	35.73		16	8	94	297	1,128	125	3
Norman Police Department 01402	2002	96,888	3,769	38.90	1	34	44	145	1,057	2,352	136	14
	2001	95,694	3,425	35.79	2	34	42	151	886	2,178	132	11
	2000	96,791	3,599	37.18		66	38	105	871	2,371	148	8
Lexington Police Department 01403	2002	2,112	44	20.83				11	3	26	4	
	2001	2,086	47	22.53		1		3	13	26	4	
	2000	1,976	49	24.80		1		8	11	28	1	
Noble Police Department 01404	2002	5,326	105	19.71				4	22	70	9	1
	2001	5,260	151	28.71		1		12	37	85	16	1
	2000	5,492	165	30.04		1		6	46	100	12	
University of Oklahoma Police * 01405	2002	31,533	331	10.50		2	3	1	39	275	11	4
	2001	28,858	340	11.78		2	1	1	54	273	9	9
	2000	26,002	332	12.77		2	1	2	41	274	12	10
Norman Public Schools * 01408	2002	14,190	113	7.96				3	3	105	2	2
	2001	Reported Through the County SO										
	2000	Reported Through the County SO										
CLEVELAND COUNTY	2002	162,751	6,445	39.60	1	73	62	305	1,584	4,116	304	33
	2001	160,745	6,143	38.22	4	70	64	438	1,480	3,710	377	33
	2000	165,626	6,221	37.56		93	49	273	1,418	4,060	328	26
Coal County Sheriff's Office 01500	2002	4,076	120	29.44	1	1		7	29	75	7	3
	2001	4,026	75	18.63	1	1		10	12	36	15	
	2000	4,341	60	13.82	1		1	9	14	25	10	5
Coalgate Police Department 01501	2002	2,030	56	27.59				20	12	22	2	2
	2001	2,005	110	54.86				33	21	54	2	1
	2000	1,954	120	61.41				34	14	70	2	1

OKLAHOMA STATE BUREAU OF INVESTIGATION

AGENCY	YEAR	POPULATION	TOTAL CRIME INDEX	CRIME RATE PER 1000	MURDER	RAPE	ROBBERY	FELONIOUS ASSAULT	BREAKING & ENTERING	LARCENY	MOTOR VEHICLE THEFT	ARSON
COAL COUNTY	2002	6,106	176	28.82	1	1		27	41	97	9	5
	2001	6,031	185	30.67	1	1		43	33	90	17	1
	2000	6,295	180	28.59	1		1	43	28	95	12	6
Comanche County Sheriff's Office 01600	2002	21,481	368	17.13	2	3	6	59	76	184	38	5
	2001	21,217	337	15.88		3	4	51	95	154	30	4
	2000	27,430	466	16.99	2	9	4	102	120	191	38	13
Lawton Police Department 01601	2002	93,915	5,515	58.72	6	57	151	452	1,281	3,247	321	35
	2001	92,757	5,210	56.17	6	46	148	373	1,203	3,169	265	36
	2000	82,131	5,090	61.97	3	55	119	365	1,235	3,079	234	36
Fletcher Police Department 01606	2002	1,035	30	28.99		1		5	8	14	2	
	2001	1,022	43	42.07		1		6	15	20	1	2
	2000	Reported Through the County SO										
Cameron University Police Department * 01615	2002	5,660	6	1.06						5	1	
	2001	5,901	4	0.68					1	3		
	2000	6,000	7	1.17					1	6		
COMANCHE COUNTY	2002	116,431	5,919	50.84	8	61	157	516	1,365	3,450	362	40
	2001	114,996	5,594	48.65	6	50	152	430	1,314	3,346	296	42
	2000	109,561	5,563	50.78	5	64	123	467	1,356	3,276	272	49
Cotton County Sheriff's Office 01700	2002	2,845	35	12.30			1	4	7	19	4	
	2001	2,811	28	9.96				2	7	15	4	
	2000	3,074	36	11.71				3	12	17	4	
Walters Police Department 01701	2002	2,691	35	13.01				7	6	20	2	
	2001	2,657	45	16.94				9	7	28	1	
	2000	2,277	59	25.91		2		15	3	39		2
Temple Police Department 01707	2002	1,160	17	14.66		1		2	5	7	2	
	2001	1,146	25	21.82				5	10	9	1	1
	2000	1,440	21	14.58		1		14	4	2		1

OKLAHOMA STATE BUREAU OF INVESTIGATION

AGENCY	YEAR	POPULATION	TOTAL CRIME INDEX	CRIME RATE PER 1000	MURDER	RAPE	ROBBERY	FELONIOUS ASSAULT	BREAKING & ENTERING	LARCENY	MOTOR VEHICLE THEFT	ARSON
COTTON COUNTY	2002	6,696	87	12.99		1	1	13	18	46	8	
	2001	6,614	98	14.82				16	24	52	6	1
	2000	6,791	116	17.08		3		32	19	58	4	3
Craig County Sheriff's Office 01800	2002	8,585	124	14.44		1		7	52	43	21	3
	2001	8,478	94	11.09		1		4	36	38	15	4
	2000	8,974	106	11.81		4	1	11	48	30	12	3
Vinita Police Department 01801	2002	6,552	248	37.85		1	3	18	56	154	16	1
	2001	6,472	176	27.19	1		3	18	31	110	13	1
	2000	5,893	231	39.20				14	44	156	17	5
CRAIG COUNTY	2002	15,137	372	24.58		2	3	25	108	197	37	4
	2001	14,950	270	18.06	1	1	3	22	67	148	28	5
	2000	14,867	337	22.67		4	1	25	92	186	29	8
Creek County Sheriff's Office 01900	2002	38,338	736	19.20	3	8	1	146	212	283	83	7
	2001	37,867	512	13.52		18	3	57	164	216	54	4
	2000	38,768	487	12.56		4	3	79	139	176	86	
Bristow Police Department 01901	2002	4,379	306	69.88	1	3	1	14	72	188	27	
	2001	4,325	261	60.35	1	2	2	14	41	170	31	1
	2000	4,516	251	55.58		1	3	37	38	149	23	4
Drumright Police Department 01902	2002	2,941	134	45.56		1		21	28	77	7	
	2001	2,905	145	49.91		1	1	21	29	84	9	2
	2000	2,954	110	37.24				16	24	66	4	2
Sapulpa Police Department 01903	2002	19,405	831	42.82	1	1	11	35	149	569	65	15
	2001	19,166	818	42.68		8	4	36	175	533	62	13
	2000	20,669	821	39.72		4	10	44	160	500	103	48
Mannford Police Department 01908	2002	2,121	89	41.96		4		5	14	56	10	
	2001	2,095	53	25.30		1		4	13	30	5	
	2000	2,091	64	30.61				8	7	44	5	

OKLAHOMA STATE BUREAU OF INVESTIGATION

AGENCY	YEAR	POPULATION	TOTAL CRIME INDEX	CRIME RATE PER 1000	MURDER	RAPE	ROBBERY	FELONIOUS ASSAULT	BREAKING & ENTERING	LARCENY	MOTOR VEHICLE THEFT	ARSON
Oilton Police Department 01911	2002	1,113	25	22.46			1	1	4	18	1	
	2001	1,099	11	10.01				1	4	3	3	1
	2000	1,198	8	6.68	1	2			1	3	1	2
CREEK COUNTY	2002	68,297	2,121	31.06	5	17	14	222	479	1,191	193	22
	2001	67,457	1,800	26.68	1	30	10	133	426	1,036	164	21
	2000	70,196	1,741	24.80	1	11	16	184	369	938	222	56
Custer County Sheriff's Office 02000	2002	7,545	43	5.70	1	4		7	23	5	3	2
	2001	7,452	57	7.65		2	1	3	19	27	5	
	2000	7,373	76	10.31		1	1	12	20	33	9	3
Clinton Police Department 02001	2002	8,943	289	32.32	1	5	9	14	74	172	14	2
	2001	8,833	349	39.51		2	1	22	83	228	13	3
	2000	8,888	320	36.00		2	7	14	75	205	17	1
Weatherford Police Department 02002	2002	9,982	409	40.97		3	4	26	86	278	12	
	2001	9,859	373	37.83		3	1	30	63	262	14	
	2000	10,030	430	42.87		6		36	93	272	23	
SW OSU Police * 02009	2002	5,143	49	9.53					27	22		
	2001	4,998	28	5.60		1			7	20		
	2000	5,039	26	5.16					6	18	2	
CUSTER COUNTY	2002	26,470	790	29.85	2	12	13	47	210	477	29	4
	2001	26,144	807	30.87		8	3	55	172	537	32	3
	2000	26,291	852	32.41		9	8	62	194	528	51	4
Delaware County Sheriff's Office 02100	2002	29,831	419	14.05	2	3	1	34	184	147	48	9
	2001	29,464	421	14.29	1	5	2	49	160	164	40	7
	2000	27,721	369	13.31	1	8		70	119	109	62	2
Grove Police Department 02107	2002	5,195	317	61.02				11	69	227	10	5
	2001	5,131	267	52.04		1	2	4	37	205	18	
	2000	5,689	294	51.68	1		2	25	47	205	14	3

OKLAHOMA STATE BUREAU OF INVESTIGATION

AGENCY	YEAR	POPULATION	TOTAL CRIME INDEX	CRIME RATE PER 1000	MURDER	RAPE	ROBBERY	FELONIOUS ASSAULT	BREAKING & ENTERING	LARCENY	MOTOR VEHICLE THEFT	ARSON
Jay Police Department 02108	2002	2,513	124	49.34			1		26	84	13	
	2001	2,482	71	28.61					7	59	5	
	2000	2,532	91	35.94					13	62	16	1
DELAWARE COUNTY	2002	37,539	860	22.91	2	3	2	45	279	458	71	14
	2001	37,077	759	20.47	1	6	4	53	204	428	63	7
	2000	35,942	754	20.98	2	8	2	95	179	376	92	6
Dewey County Sheriff's Office 02200	2002	3,916	48	12.26				2	11	32	3	
	2001	3,868	44	11.38		2		2	12	21	7	
	2000	4,262	57	13.37		1		2	22	28	4	
Seiling Police Department 02211	2002	886	25	28.22				7	3	15		
	2001	875	25	28.57		2		5	2	14	2	
	2000	731	47	64.30				8	13	26		
DEWEY COUNTY	2002	4,802	73	15.20				9	14	47	3	
	2001	4,743	69	14.55		4		7	14	35	9	
	2000	4,993	104	20.83		1		10	35	54	4	
Ellis County Sheriff's Office 02300	2002	4,126	14	3.39				2	8	4		
	2001	4,075	32	7.85				2	14	9	7	
	2000	4,310	33	7.66					19	8	6	
ELLIS COUNTY	2002	4,126	14	3.39				2	8	4		
	2001	4,075	32	7.85				2	14	9	7	
	2000	4,310	33	7.66					19	8	6	
Garfield County Sheriff's Office 02400	2002	9,625	169	17.56		1		2	43	115	8	6
	2001	9,507	174	18.30		1		5	34	132	2	7
	2000	10,744	197	18.34				10	41	143	3	10
Enid Police Department 02401	2002	47,632	2,985	62.67		34	25	192	638	1,969	127	4
	2001	47,045	2,953	62.77	1	30	34	170	616	1,983	119	4
	2000	46,442	2,695	58.03		24	27	165	544	1,831	104	4

OKLAHOMA STATE BUREAU OF INVESTIGATION

AGENCY	YEAR	POPULATION	TOTAL CRIME INDEX	CRIME RATE PER 1000	MURDER	RAPE	ROBBERY	FELONIOUS ASSAULT	BREAKING & ENTERING	LARCENY	MOTOR VEHICLE THEFT	ARSON
Waukomis Police Department 02417	2002	1,277	17	13.31				1	4	12		1
	2001	1,261	38	30.13					17	20	1	
	2000	1,339	33	24.65					12	21		
GARFIELD COUNTY	2002	58,534	3,171	54.17		35	25	195	685	2,096	135	11
	2001	57,813	3,165	54.75	1	31	34	175	667	2,135	122	11
	2000	58,525	2,925	49.98		24	27	175	597	1,995	107	14
Garvin County Sheriff's Office 02500	2002	13,072	138	10.56			1	22	46	52	17	1
	2001	12,155	117	9.63		2		10	33	59	13	4
	2000	13,193	130	9.85	1	1	2	23	38	57	8	3
Lindsay Police Department 02501	2002	2,925	77	26.32				1	15	59	2	
	2001	2,889	90	31.15		1		6	32	47	4	
	2000	2,854	85	29.78		2		6	25	48	4	
Pauls Valley Police Department 02502	2002	6,334	418	65.99	1	5	3	23	107	259	20	2
	2001	6,256	439	70.17	1	5	6	16	94	294	23	
	2000	5,813	483	83.09		3	8	23	68	368	13	3
Wynnewood Police Department 02503	2002	2,397	69	28.79		1		3	21	42	2	
	2001	2,367	87	36.76				6	21	51	9	1
	2000	2,357	84	35.64				12	22	48	2	
Elmore City Police Department 02505	2002	Reported Through the County SO										
	2001	756	10	13.23				2	6	2		
	2000	535	8	14.95					7	1		
Maysville Police Department 02509	2002	1,329	42	31.60				16	5	20	1	
	2001	1,313	45	34.27				6	6	33		1
	2000	1,145	34	29.69				10	6	15	3	
Stratford Police Department 02513	2002	1,492	27	18.10				3	5	17	2	
	2001	1,474	41	27.82		2	1	5	8	22	3	
	2000	1,557	33	21.19		1	1	9	11	11		

OKLAHOMA STATE BUREAU OF INVESTIGATION

AGENCY	YEAR	POPULATION	TOTAL CRIME INDEX	CRIME RATE PER 1000	MURDER	RAPE	ROBBERY	FELONIOUS ASSAULT	BREAKING & ENTERING	LARCENY	MOTOR VEHICLE THEFT	ARSON
GARVIN COUNTY	2002	27,549	771	27.99	1	6	4	68	199	449	44	3
	2001	27,210	829	30.47	1	10	7	51	200	508	52	6
	2000	27,454	857	31.22	1	7	11	83	177	548	30	6
Grady County Sheriff's Office 02600	2002	22,666	273	12.04	3	7	1	17	77	150	18	4
	2001	22,387	282	12.60	5	6	1	21	92	135	22	4
	2000	21,847	239	10.94		3	2	27	74	113	20	1
Chickasha Police Department 02601	2002	16,048	1,300	81.01		15	19	199	254	757	56	7
	2001	15,850	1,097	69.21	1	11	11	173	246	599	56	4
	2000	17,035	1,032	60.58	2	17	21	171	210	557	54	7
Minco Police Department 02609	2002	1,693	21	12.40				1	6	12	2	2
	2001	1,672	37	22.13	1		1	5	4	19	7	
	2000	1,595	16	10.03				2		14		
Ninnekah Police Department 02610	2002	Reported Through the County SO										
	2001	Reported Through the County SO										
	2000	1,145	14	12.23				1	6	5	2	
Rush Springs Police Department 02613	2002	1,294	54	41.73	1			9	13	27	4	
	2001	1,278	40	31.30				5	16	16	3	1
	2000	1,329	36	27.09				7	9	16	4	
Tuttle Police Department 02615	2002	4,348	102	23.46				12	19	65	6	
	2001	4,294	103	23.99		2		4	34	56	7	
	2000	4,338	112	25.82			1	18	27	55	11	5
GRADY COUNTY	2002	46,049	1,750	38.00	4	22	20	238	369	1,011	86	13
	2001	45,481	1,559	34.28	7	19	13	208	392	825	95	9
	2000	47,289	1,449	30.64	2	20	24	226	326	760	91	13
Grant County Sheriff's Office 02700	2002	5,208	97	18.63		1			30	62	4	1
	2001	5,144	100	19.44					27	72	1	1
	2000	5,381	85	15.80				1	28	54	2	6

OKLAHOMA STATE BUREAU OF INVESTIGATION

AGENCY	YEAR	POPULATION	TOTAL CRIME INDEX	CRIME RATE PER 1000	MURDER	RAPE	ROBBERY	FELONIOUS ASSAULT	BREAKING & ENTERING	LARCENY	MOTOR VEHICLE THEFT	ARSON
GRANT COUNTY	2002	5,208	97	18.63		1			30	62	4	1
	2001	5,144	100	19.44					27	72	1	1
	2000	5,381	85	15.80				1	28	54	2	6
Greer County Sheriff's Office 02800	2002	1,309	26	19.86			1	1	8	14	2	
	2001	1,293	51	39.44				1	21	25	4	1
	2000	1,599	27	16.89				2	10	12	3	1
Mangum Police Department 02801	2002	2,960	63	21.28				1	20	40	2	1
	2001	2,924	98	33.52				1	30	61	6	
	2000	2,967	95	32.02					19	73	3	1
Granite Police Department 02803	2002	1,867	41	21.96				1		40		
	2001	1,844	15	8.13				2	4	3	6	1
	2000	1,997	20	10.02	1			1	12	6		1
GREER COUNTY	2002	6,136	130	21.19			1	3	28	94	4	1
	2001	6,061	164	27.06				4	55	89	16	2
	2000	6,563	142	21.64	1			3	41	91	6	3
Harmon County Sheriff's Office 02900	2002	1,032	16	15.50					1	14	1	
	2001	1,019	11	10.79						9	2	2
	2000	1,050	23	21.90						22	1	
Hollis Police Department 02901	2002	2,292	97	42.32		1		5	28	59	4	1
	2001	2,264	84	37.10		1	1	10	30	40	2	1
	2000	2,378	124	52.14			5	7	41	67	4	2
HARMON COUNTY	2002	3,324	113	34.00		1		5	29	73	5	1
	2001	3,283	95	28.94		1	1	10	30	49	4	3
	2000	3,428	147	42.88			5	7	41	89	5	2
Harper County Sheriff's Office 03000	2002	1,281	30	23.42				3	4	21	2	1
	2001	2,465	33	13.39		1		3	5	21	3	
	2000	2,522	31	12.29				2	6	23		

OKLAHOMA STATE BUREAU OF INVESTIGATION

AGENCY	YEAR	POPULATION	TOTAL CRIME INDEX	CRIME RATE PER 1000	MURDER	RAPE	ROBBERY	FELONIOUS ASSAULT	BREAKING & ENTERING	LARCENY	MOTOR VEHICLE THEFT	ARSON
Buffalo Police Department 03001	2002	1,215	28	23.05				5	12	11		1
	2001	Reported Through the County SO										
	2000	Reported Through the County SO										
Laverne Police Department 03002	2002	1,111	18	16.20			2		9	6	1	
	2001	1,097	12	10.94				2	2	7	1	
	2000	1,157	19	16.42				1	8	8	2	
HARPER COUNTY	2002	3,607	76	21.07			2	8	25	38	3	2
	2001	3,562	45	12.63		1		5	7	28	4	
	2000	3,679	50	13.59				3	14	31	2	
Haskell County Sheriff's Office 03100	2002	9,174	56	6.10		1		7	9	33	6	
	2001	9,061	80	8.83	1			12	18	37	12	
	2000	9,203	114	12.39				12	50	45	7	
Stigler Police Department 03101	2002	2,765	69	24.95				14	11	39	5	1
	2001	2,731	70	25.63				7	1	62		2
	2000	2,533	95	37.50				4	7	80	4	
HASKELL COUNTY	2002	11,939	125	10.47		1		21	20	72	11	1
	2001	11,792	150	12.72	1			19	19	99	12	2
	2000	11,736	209	17.81				16	57	125	11	
Hughes County Sheriff's Office 03200	2002	8,071	103	12.76				4	52	36	11	3
	2001	7,971	118	14.80			1	12	34	53	18	1
	2000	6,912	137	19.82	2	1		11	52	63	8	3
Holdenville Police Department 03201	2002	4,791	153	31.93			1	17	33	93	9	3
	2001	4,732	188	39.73	2			30	44	108	4	
	2000	6,029	190	31.51		1	1	13	43	122	10	1
Wetumka Police Department 03202	2002	1,469	80	54.46		2		7	38	26	7	3
	2001	1,451	106	73.05			2	15	40	41	8	1
	2000	1,511	82	54.27		1		10	29	34	8	3

OKLAHOMA STATE BUREAU OF INVESTIGATION

AGENCY	YEAR	POPULATION	TOTAL CRIME INDEX	CRIME RATE PER 1000	MURDER	RAPE	ROBBERY	FELONIOUS ASSAULT	BREAKING & ENTERING	LARCENY	MOTOR VEHICLE THEFT	ARSON
HUGHES COUNTY	2002	14,331	336	23.45		2	1	28	123	155	27	9
	2001	14,154	412	29.11	2		3	57	118	202	30	2
	2000	14,452	409	28.30	2	3	1	34	124	219	26	7
Jackson County Sheriff's Office 03300	2002	7,079	98	13.84				10	42	39	7	1
	2001	6,992	93	13.30				16	47	25	5	
	2000	7,615	76	9.98		1		18	26	25	6	
Altus Police Department 03301	2002	21,715	1,165	53.65	2	16	17	22	439	637	32	2
	2001	21,447	1,236	57.63	2	9	22	35	475	670	23	3
	2000	21,560	1,315	60.99		12	16	58	383	815	31	5
JACKSON COUNTY	2002	28,794	1,263	43.86	2	16	17	32	481	676	39	3
	2001	28,439	1,329	46.73	2	9	22	51	522	695	28	3
	2000	29,175	1,391	47.68		13	16	76	409	840	37	5
Jefferson County Sheriff's Office 03400	2002	3,741	86	22.99			1	13	20	42	10	1
	2001	3,695	69	18.67				9	17	38	5	2
	2000	3,631	46	12.67		3		12	12	16	3	
Ringling Police Department 03408	2002	1,149	12	10.44		1		1	1	9		1
	2001	1,135	9	7.93					1	5	3	
	2000	1,279	19	14.86				2	5	10	2	
Waurika Police Department 03412	2002	2,013	73	36.26		1		25	8	35	4	
	2001	1,988	61	30.68		2		15	13	29	2	
	2000	1,788	47	26.29				3	10	31	3	3
JEFFERSON COUNTY	2002	6,903	171	24.77		2	1	39	29	86	14	2
	2001	6,818	139	20.39		2		24	31	72	10	2
	2000	6,698	112	16.72		3		17	27	57	8	3
Johnston County Sheriff's Office 03500	2002	7,444	86	11.55		1		22	23	27	13	1
	2001	7,351	116	15.78		5	1	40	34	29	7	
	2000	7,528	99	13.15		1	1	36	38	16	7	

OKLAHOMA STATE BUREAU OF INVESTIGATION

AGENCY	YEAR	POPULATION	TOTAL CRIME INDEX	CRIME RATE PER 1000	MURDER	RAPE	ROBBERY	FELONIOUS ASSAULT	BREAKING & ENTERING	LARCENY	MOTOR VEHICLE THEFT	ARSON
Tishomingo Police Department 03501	2002	3,201	81	25.30		1	2	6	33	33	6	2
	2001	3,162	55	17.39				5	16	28	6	1
	2000	3,066	56	18.26			1	6	15	31	3	2
Murray State College * 03518	2002	2,252	16	7.10				1	5	9	1	
	2001	1,405	10	7.12					6	4		1
	2000	2,000	7	3.50					2	5		
JOHNSTON COUNTY	2002	10,645	183	17.19		2	2	29	61	69	20	3
	2001	10,513	181	17.22		5	1	45	56	61	13	2
	2000	10,594	162	15.29		1	2	42	55	52	10	2
Kay County Sheriff's Office 03600	2002	9,063	305	33.65		4	2	43	53	181	22	10
	2001	8,951	274	30.61		3	1	28	76	152	14	3
	2000	8,404	272	32.37		4	1	29	65	161	12	3
Blackwell Police Department 03601	2002	7,764	382	49.20		3	2	19	76	265	17	2
	2001	7,668	317	41.34	1	5	2	32	87	170	20	3
	2000	7,342	326	44.40		3	3	36	87	184	13	8
Newkirk Police Department 03602	2002	2,271	133	58.56				13	15	102	3	2
	2001	2,243	215	95.85		3	2	18	17	171	4	1
	2000	2,152	125	58.09			1	18	19	87		
Ponca City Police Department 03603	2002	26,242	1,542	58.76		29	18	156	291	952	96	22
	2001	25,919	1,423	54.90	2	24	15	85	279	930	88	7
	2000	26,770	1,391	51.96	3	27	19	72	287	908	75	15
Tonkawa Police Department 03604	2002	3,340	113	33.83		1		10	16	79	7	1
	2001	3,299	104	31.52			1	9	20	70	4	
	2000	3,065	105	34.26			1	15	22	60	7	1
KAY COUNTY	2002	48,680	2,475	50.84		37	22	241	451	1,579	145	37
	2001	48,080	2,333	48.52	3	35	21	172	479	1,493	130	14
	2000	47,733	2,219	46.49	3	34	25	170	480	1,400	107	27

OKLAHOMA STATE BUREAU OF INVESTIGATION

AGENCY	YEAR	POPULATION	TOTAL CRIME INDEX	CRIME RATE PER 1000	MURDER	RAPE	ROBBERY	FELONIOUS ASSAULT	BREAKING & ENTERING	LARCENY	MOTOR VEHICLE THEFT	ARSON
Kingfisher County Sheriff's Office 03700	2002	9,664	100	10.35				10	25	50	15	
	2001	9,546	59	6.18			1	1	13	41	3	
	2000	7,512	64	8.52				2	25	36	1	1
Hennessey Police Department 03701	2002	Reported Through the County SO										
	2001	Reported Through the County SO										
	2000	1,926	12	6.23			1	2	3	4	2	1
Kingfisher Police Department 03702	2002	4,435	140	31.57				2	25	100	13	
	2001	4,380	132	30.14				1	32	91	8	
	2000	4,398	171	38.88			1	1	32	129	8	
KINGFISHER COUNTY	2002	14,099	240	17.02				12	50	150	28	
	2001	13,926	191	13.72			1	2	45	132	11	
	2000	13,836	247	17.85			2	5	60	169	11	2
Kiowa County Sheriff's Office 03800	2002	3,889	58	14.91		1		3	26	25	3	4
	2001	3,841	103	26.82				4	45	49	5	4
	2000	4,525	80	17.68				7	26	40	7	4
Hobart Police Department 03801	2002	4,047	187	46.21		1	5	23	55	97	6	
	2001	3,997	158	39.53	1	1	5	8	63	75	5	
	2000	3,837	121	31.54	1	1	1	14	35	62	7	
Snyder Police Department 03811	2002	1,528	54	35.34	1	1	1	6	26	17	2	
	2001	1,509	61	40.42		2	1	13	21	23	1	1
	2000	1,447	55	38.01		1		12	19	20	3	2
Mountain View Police Department 03814	2002	891	3	3.37						3		
	2001	880	7	7.95				2	1	4		1
	2000	979	19	19.41				1	1	15	2	
KIOWA COUNTY	2002	10,355	302	29.16	1	3	6	32	107	142	11	4
	2001	10,227	329	32.17	1	3	6	27	130	151	11	6
	2000	10,788	275	25.49	1	2	1	34	81	137	19	6

OKLAHOMA STATE BUREAU OF INVESTIGATION

AGENCY	YEAR	POPULATION	TOTAL CRIME INDEX	CRIME RATE PER 1000	MURDER	RAPE	ROBBERY	FELONIOUS ASSAULT	BREAKING & ENTERING	LARCENY	MOTOR VEHICLE THEFT	ARSON
Latimer County Sheriff's Office 03900	2002	7,817	76	9.72				11	19	39	7	
	2001	7,720	80	10.36		1		13	23	33	10	
	2000	7,236	82	11.33				12	35	30	5	1
Wilburton Police Department 03901	2002	3,009	110	36.56			2	26	22	52	8	1
	2001	2,972	93	31.29			1	20	25	44	3	1
	2000	3,249	92	28.32			1	29	12	46	4	3
LATIMER COUNTY	2002	10,826	186	17.18			2	37	41	91	15	1
	2001	10,692	173	16.18		1	1	33	48	77	13	1
	2000	10,485	174	16.60			1	41	47	76	9	4
LeFlore County Sheriff's Office 04000	2002	26,537	310	11.68	1	13		50	105	91	50	2
	2001	26,210	226	8.62	4	3	3	58	73	65	20	5
	2000	26,324	246	9.35	5	1	3	30	86	91	30	1
Poteau Police Department 04001	2002	8,039	337	41.92	1		2	16	62	241	15	4
	2001	7,939	309	38.92			1	34	58	197	19	1
	2000	8,007	320	39.97	1		3	28	52	214	22	
Talihina Police Department 04002	2002	1,226	103	84.01	1	3		6	36	51	6	
	2001	1,211	68	56.15		2		9	10	45	2	
	2000	1,455	88	60.48		1	1	19	15	49	3	1
Arkoma Police Department 04003	2002	2,207	42	19.03				6	13	19	4	
	2001	2,180	61	27.98		1		19	18	21	2	
	2000	2,365	19	8.03				2	3	10	4	1
Bokoshe Police Department 04005	2002	455	9	19.78				3		2	4	
	2001	450	9	20.00		2		1	5		1	
	2000	460	3	6.52		1				2		
Heavener Police Department 04011	2002	3,241	91	28.08		1		16	20	45	9	
	2001	3,201	114	35.61		1		22	20	64	7	1
	2000	2,511	107	42.61		2	1	17	29	48	10	

OKLAHOMA STATE BUREAU OF INVESTIGATION

AGENCY	YEAR	POPULATION	TOTAL CRIME INDEX	CRIME RATE PER 1000	MURDER	RAPE	ROBBERY	FELONIOUS ASSAULT	BREAKING & ENTERING	LARCENY	MOTOR VEHICLE THEFT	ARSON
Howe Police Department 04014	2002	706	14	19.83				5	3	6		2
	2001	697	17	24.39				7	2	7	1	
	2000	530	2	3.77				1		1		
Pocola Police Department 04023	2002	4,044	86	21.27			1	25	19	33	8	2
	2001	3,994	79	19.78		3		5	28	37	6	
	2000	3,896	76	19.51		2	1	2	26	38	7	1
Spiro Police Department 04027	2002	2,255	80	35.48		1	1	9	24	37	8	
	2001	2,227	71	31.88				6	22	37	6	
	2000	2,512	50	19.90				1	17	29	3	
LEFLORE COUNTY	2002	48,710	1,072	22.01	3	18	4	136	282	525	104	10
	2001	48,109	954	19.83	4	12	4	161	236	473	64	7
	2000	48,060	911	18.96	6	7	9	100	228	482	79	4
Lincoln County Sheriff's Office 04100	2002	23,298	266	11.42	3	4	1	40	106	84	28	2
	2001	23,011	308	13.38		3	1	63	113	104	24	2
	2000	23,082	174	7.54	1	2		8	77	69	17	5
Chandler Police Department 04101	2002	2,878	175	60.81		2	1	15	60	92	5	3
	2001	2,842	146	51.37		1		21	37	77	10	1
	2000	2,831	146	51.57		2	1	35	27	78	3	4
Prague Police Department 04102	2002	2,165	76	35.10				19	8	46	3	
	2001	2,138	72	33.68				12	21	34	5	
	2000	2,396	86	35.89				14	17	53	2	1
Stroud Police Department 04103	2002	2,792	63	22.56		4		5	13	37	4	
	2001	2,758	69	25.02				6	17	41	5	
	2000	2,997	57	19.02			1	5	12	36	3	
Agra Police Department 04104	2002	360	4	11.11					1	3		
	2001	356	2	5.62					1	1		1
	2000	370	0	0.00								

OKLAHOMA STATE BUREAU OF INVESTIGATION

AGENCY	YEAR	POPULATION	TOTAL CRIME INDEX	CRIME RATE PER 1000	MURDER	RAPE	ROBBERY	FELONIOUS ASSAULT	BREAKING & ENTERING	LARCENY	MOTOR VEHICLE THEFT	ARSON
Meeker Police Department 04111	2002	990	69	69.70				18	15	33	3	1
	2001	978	34	34.76				9	7	17	1	1
	2000	1,041	17	16.33				1		16		
LINCOLN COUNTY	2002	32,483	653	20.10	3	10	2	97	203	295	43	6
	2001	32,083	631	19.67		4	1	111	196	274	45	5
	2000	32,717	480	14.67	1	4	2	63	133	252	25	10
Logan County Sheriff's Office 04200	2002	23,002	307	13.35	2	5	3	36	117	127	17	5
	2001	22,718	174	7.66	1	2	1	32	81	41	16	2
	2000	19,592	195	9.95		3	2	31	76	65	18	9
Guthrie Police Department 04201	2002	10,048	438	43.59	1	5	6	48	94	272	12	9
	2001	9,925	522	52.59		6	9	49	166	282	10	6
	2000	10,449	526	50.34		10	8	51	152	280	25	6
Crescent Police Department 04203	2002	1,297	32	24.67				6	5	15	6	
	2001	1,281	26	20.30					6	19	1	2
	2000	1,235	28	22.67		1	1	2	10	13	1	
LOGAN COUNTY	2002	34,347	777	22.62	3	10	9	90	216	414	35	14
	2001	33,924	722	21.28	1	8	10	81	253	342	27	10
	2000	31,276	749	23.95		14	11	84	238	358	44	15
Love County Sheriff's Office 04300	2002	6,466	115	17.79		3		14	34	53	11	4
	2001	6,386	98	15.35	1	1	1	19	31	38	7	4
	2000	6,202	79	12.74	1			15	26	33	4	4
Marietta Police Department 04301	2002	2,475	70	28.28			1	8	16	44	1	2
	2001	2,445	74	30.27		1	1	8	8	54	2	
	2000	2,616	111	42.43		1		3	14	89	4	2
LOVE COUNTY	2002	8,941	185	20.69		3	1	22	50	97	12	6
	2001	8,831	172	19.48	1	2	2	27	39	92	9	4
	2000	8,818	190	21.55	1	1		18	40	122	8	6

OKLAHOMA STATE BUREAU OF INVESTIGATION

AGENCY	YEAR	POPULATION	TOTAL CRIME INDEX	CRIME RATE PER 1000	MURDER	RAPE	ROBBERY	FELONIOUS ASSAULT	BREAKING & ENTERING	LARCENY	MOTOR VEHICLE THEFT	ARSON
McClain County Sheriff's Office 04400	2002	14,127	193	13.66		3	1	27	56	87	19	
	2001	13,954	190	13.62	2	3		13	72	81	19	5
	2000	13,289	200	15.05	1	4	1	33	71	66	24	4
Blanchard Police Department 04401	2002	2,851	77	27.01			1	21	14	36	5	2
	2001	2,816	68	24.15				18	11	31	8	
	2000	2,943	63	21.41				3	20	35	5	1
Purcell Police Department 04402	2002	5,641	289	51.23		5	5	15	92	165	7	1
	2001	5,571	397	71.26		3	2	47	112	213	20	4
	2000	5,415	310	57.25		2	3	40	67	181	17	1
Dibble Police Department 04406	2002	Reported Through the County SO										
	2001	Reported Through the County SO										
	2000	219	8	36.53					1	6	1	1
Newcastle Police Department 04408	2002	5,502	197	35.81		1		26	47	107	16	2
	2001	5,434	193	35.52		3	1	6	50	122	11	2
	2000	5,673	158	27.85				16	21	108	13	1
MCCLAIN COUNTY	2002	28,121	756	26.88		9	7	89	209	395	47	5
	2001	27,775	848	30.53	2	9	3	84	245	447	58	11
	2000	27,539	739	26.83	1	6	4	92	180	396	60	8
McCurtain County Sheriff's Office 04500	2002	21,871	478	21.86	2	7	1	94	114	215	45	19
	2001	21,601	536	24.81	3	7	2	168	150	154	52	22
	2000	21,563	357	16.56	2	3	4	66	113	127	42	19
Broken Bow Police Department 04501	2002	4,283	314	73.31		3	2	19	59	216	15	4
	2001	4,230	271	64.07	2	2		22	72	159	14	5
	2000	4,855	309	63.65		4	2	45	77	167	14	5
Idabel Police Department 04502	2002	7,039	429	60.95		7	10	56	70	271	15	2
	2001	6,952	418	60.13	1	2		54	65	275	21	2
	2000	7,572	454	59.96	2	6	4	71	84	268	19	

OKLAHOMA STATE BUREAU OF INVESTIGATION

AGENCY	YEAR	POPULATION	TOTAL CRIME INDEX	CRIME RATE PER 1000	MURDER	RAPE	ROBBERY	FELONIOUS ASSAULT	BREAKING & ENTERING	LARCENY	MOTOR VEHICLE THEFT	ARSON
Valliant Police Department 04516	2002	780	16	20.51				4	4	7	1	
	2001	771	20	25.94	1			4	7	8		
	2000	947	7	7.39				1		5	1	
Wright City Police Department 04518	2002	859	21	24.45			1	4	5	11		1
	2001	848	19	22.41				6	4	9		
	2000	818	29	35.45				6	5	18		1
MCCURTAIN COUNTY	2002	34,832	1,258	36.12	2	17	14	177	252	720	76	26
	2001	34,402	1,264	36.74	7	11	2	254	298	605	87	29
	2000	35,755	1,156	32.33	4	13	10	189	279	585	76	25
McIntosh County Sheriff's Office 04600	2002	13,504	330	24.44	1		2	11	115	156	45	5
	2001	13,336	355	26.62	1	1	1	26	107	173	46	2
	2000	12,463	398	31.93	2	3	1	32	127	197	36	7
Checotah Police Department 04601	2002	3,524	205	58.17		1		20	24	149	11	1
	2001	3,481	196	56.31		3	1	13	28	127	24	
	2000	3,751	234	62.38		2	1	9	38	152	32	2
Eufaula Police Department 04602	2002	2,671	184	68.89		1		19	30	121	13	4
	2001	2,639	157	59.49		3		26	28	93	7	4
	2000	3,586	165	46.01				8	25	124	8	
MCINTOSH COUNTY	2002	19,699	719	36.50	1	2	2	50	169	426	69	10
	2001	19,456	708	36.39	1	7	2	65	163	393	77	6
	2000	19,800	797	40.25	2	5	2	49	190	473	76	9
Major County Sheriff's Office 04700	2002	4,872	89	18.27				10	25	52	2	7
	2001	4,812	118	24.52		2		5	43	65	3	3
	2000	5,137	80	15.57				2	20	55	3	1
Fairview Police Department 04701	2002	2,767	78	28.19				9	21	47	1	
	2001	2,733	77	28.17		1		2	20	52	2	
	2000	2,733	58	21.22		1		3	11	42	1	

OKLAHOMA STATE BUREAU OF INVESTIGATION

AGENCY	YEAR	POPULATION	TOTAL CRIME INDEX	CRIME RATE PER 1000	MURDER	RAPE	ROBBERY	FELONIOUS ASSAULT	BREAKING & ENTERING	LARCENY	MOTOR VEHICLE THEFT	ARSON
MAJOR COUNTY	2002	7,639	167	21.86				19	46	99	3	7
	2001	7,545	195	25.84		3		7	63	117	5	3
	2000	7,870	138	17.53		1		5	31	97	4	1
Marshall County Sheriff's Office 04800	2002	8,487	145	17.08		2		8	49	76	10	2
	2001	8,384	164	19.56		3		16	79	55	11	3
	2000	7,915	149	18.83	2	1		12	74	54	6	2
Madill Police Department 04801	2002	3,453	106	30.70		2		5	18	74	7	
	2001	3,410	90	26.39		1	1	4	15	67	2	3
	2000	3,226	102	31.62		1	2	14	24	59	2	2
Kingston Police Department 04803	2002	1,408	51	36.22	1	2		5	15	23	5	
	2001	1,390	16	11.51				2	6	8		
	2000	1,577	21	13.32				2	3	10	6	
MARSHALL COUNTY	2002	13,348	302	22.63	1	6		18	82	173	22	2
	2001	13,184	270	20.48		4	1	22	100	130	13	6
	2000	12,718	272	21.39	2	2	2	28	101	123	14	4
Mayes County Sheriff's Office 04900	2002	26,741	425	15.89		4		53	164	159	45	
	2001	26,413	411	15.56	3		1	30	162	174	41	1
	2000	26,489	280	10.57		2	1	54	92	103	28	
Chouteau Police Department 04901	2002	1,956	162	82.82		1	1	6	22	128	4	1
	2001	1,931	174	90.11				4	6	160	4	
	2000	2,082	161	77.33		1			8	146	6	
Pryor Police Department 04902	2002	8,767	428	48.82	1	3	1	70	71	240	42	
	2001	8,659	479	55.32		5	2	48	68	308	48	
	2000	9,234	527	57.07	1	7	5	44	92	322	56	1
Locust Grove Police Department 04908	2002	1,383	91	65.80		2		15	26	46	2	1
	2001	1,366	55	40.26				12	6	33	4	1
	2000	1,520	41	26.97				2	6	27	6	

OKLAHOMA STATE BUREAU OF INVESTIGATION

AGENCY	YEAR	POPULATION	TOTAL CRIME INDEX	CRIME RATE PER 1000	MURDER	RAPE	ROBBERY	FELONIOUS ASSAULT	BREAKING & ENTERING	LARCENY	MOTOR VEHICLE THEFT	ARSON
MAYES COUNTY	2002	38,847	1,106	28.47	1	10	2	144	283	573	93	2
	2001	38,369	1,119	29.16	3	5	3	94	242	675	97	2
	2000	39,325	1,009	25.66	1	10	6	100	198	598	96	1
Murray County Sheriff's Office 05000	2002	5,284	91	17.22		1	1	14	29	36	10	
	2001	5,219	75	14.37		1		10	32	27	5	
	2000	4,786	72	15.04			1	12	26	28	5	
Sulphur Police Department 05001	2002	4,854	178	36.67		5	1	32	49	84	7	3
	2001	4,794	152	31.71				11	30	107	4	1
	2000	5,193	126	24.26	1		3	18	16	86	2	4
Davis Police Department 05002	2002	2,642	86	32.55				7	16	59	4	1
	2001	2,610	65	24.90			1	3	19	35	7	
	2000	2,845	69	24.25		1		5	19	37	7	
MURRAY COUNTY	2002	12,780	355	27.78		6	2	53	94	179	21	4
	2001	12,623	292	23.13		1	1	24	81	169	16	1
	2000	12,824	267	20.82	1	1	4	35	61	151	14	4
Muskogee County Sheriff's Office 05100	2002	23,465	393	16.75	2	7	7	68	120	135	54	10
	2001	23,167	477	20.59	4	7	6	117	129	156	58	4
	2000	23,956	365	15.24	4	10	3	115	93	100	40	1
Muskogee Police Department 05101	2002	38,788	2,318	59.76		18	68	198	685	1,199	150	16
	2001	38,310	2,872	74.97	4	25	63	250	930	1,373	227	16
	2000	39,492	2,669	67.58	7	11	70	220	797	1,349	215	15
Fort Gibson Police Department 05107	2002	4,104	66	16.08		2	2	16	9	33	4	
	2001	4,054	39	9.62		1		15	8	10	5	
	2000	3,889	63	16.20				8	11	26	18	
Haskell Police Department 05108	2002	1,787	30	16.79					11	18	1	
	2001	1,765	40	22.66		4		1	10	15	10	
	2000	2,113	29	13.72		1		2	6	17	3	

OKLAHOMA STATE BUREAU OF INVESTIGATION

AGENCY	YEAR	POPULATION	TOTAL CRIME INDEX	CRIME RATE PER 1000	MURDER	RAPE	ROBBERY	FELONIOUS ASSAULT	BREAKING & ENTERING	LARCENY	MOTOR VEHICLE THEFT	ARSON
Porum Police Department 05112	2002	734	24	32.70				4	5	13	2	
	2001	725	22	30.34			1	2	4	11	4	1
	2000	918	22	23.97		1		4	6	11		
Warner Police Department 05116	2002	1,448	39	26.93					8	28	3	2
	2001	1,430	38	26.57				1	8	25	4	1
	2000	1,656	40	24.15			2	1	10	20	7	
MUSKOGEE COUNTY	2002	70,326	2,870	40.81	2	27	77	286	838	1,426	214	28
	2001	69,451	3,488	50.22	8	37	70	386	1,089	1,590	308	22
	2000	72,024	3,188	44.26	11	23	75	350	923	1,523	283	16
Noble County Sheriff's Office 05200	2002	6,258	87	13.90				3	31	46	7	1
	2001	6,181	112	18.12					24	78	10	1
	2000	6,142	43	7.00				1	12	30		
Perry Police Department 05201	2002	5,296	117	22.09				4	15	87	11	1
	2001	5,230	97	18.55			1	13	15	60	8	2
	2000	5,505	92	16.71			2	14	18	55	3	
NOBLE COUNTY	2002	11,554	204	17.66				7	46	133	18	2
	2001	11,411	209	18.32			1	13	39	138	18	3
	2000	11,647	135	11.59			2	15	30	85	3	
Nowata County Sheriff's Office 05300	2002	6,680	103	15.42		1		13	29	47	13	3
	2001	6,598	104	15.76				12	35	53	4	
	2000	6,550	138	21.07		2	2	19	48	55	12	3
Nowata Police Department 05301	2002	4,021	190	47.25		3	2	10	35	134	6	1
	2001	3,971	192	48.35		1	1	9	50	125	6	2
	2000	3,807	195	51.22		1	2	7	42	135	8	2
NOWATA COUNTY	2002	10,701	293	27.38		4	2	23	64	181	19	4
	2001	10,569	296	28.01		1	1	21	85	178	10	2
	2000	10,357	333	32.15		3	4	26	90	190	20	5

OKLAHOMA STATE BUREAU OF INVESTIGATION

AGENCY	YEAR	POPULATION	TOTAL CRIME INDEX	CRIME RATE PER 1000	MURDER	RAPE	ROBBERY	FELONIOUS ASSAULT	BREAKING & ENTERING	LARCENY	MOTOR VEHICLE THEFT	ARSON
Okfuskee County Sheriff's Office 05400	2002	7,859	80	10.18			3	10	33	23	11	2
	2001	7,762	97	12.50		2		8	39	40	8	
	2000	7,580	89	11.74	3			1	42	35	8	2
Okemah Police Department 05401	2002	3,076	108	35.11				9	20	75	4	4
	2001	3,038	116	38.18		3		14	17	78	4	3
	2000	2,934	113	38.51				11	18	78	6	3
Weleetka Police Department 05402	2002	1,027	172	167.48				36	75	59	2	1
	2001	1,014	217	214.00		2		34	84	96	1	1
	2000	1,038	178	171.48				21	92	65		
OKFUSKEE COUNTY	2002	11,962	360	30.10			3	55	128	157	17	7
	2001	11,814	430	36.40		7		56	140	214	13	4
	2000	11,552	380	32.89	3			33	152	178	14	5
Oklahoma County Sheriff's Office 05500	2002	15,926	233	14.63	1			33	78	103	18	
	2001	15,726	220	13.99	1	1	2	24	75	102	15	1
	2000	13,914	250	17.97		3		30	83	117	17	2
Bethany Police Department 05501	2002	20,560	853	41.49	1	9	16	47	174	555	51	6
	2001	20,307	824	40.58		9	5	54	180	526	50	9
	2000	20,646	836	40.49		11	14	81	130	537	63	13
Del City Police Department 05502	2002	22,404	1,044	46.60		14	35	58	239	599	99	11
	2001	22,128	1,040	47.00	2	12	28	49	280	576	93	22
	2000	24,336	1,081	44.42	1	18	22	56	251	625	108	15
Edmond Police Department 05503	2002	69,168	1,761	25.46	1	15	14	43	385	1,229	74	11
	2001	68,315	1,736	25.41	1	17	15	35	322	1,268	78	12
	2000	68,598	1,581	23.05		14	18	19	299	1,138	93	13
Midwest City Police Department 05504	2002	54,763	2,318	42.33	1	20	36	117	574	1,395	175	10
	2001	54,088	1,981	36.63	1	15	50	89	414	1,220	192	11
	2000	55,666	2,257	40.55	4	15	52	94	414	1,469	209	7

OKLAHOMA STATE BUREAU OF INVESTIGATION

AGENCY	YEAR	POPULATION	TOTAL CRIME INDEX	CRIME RATE PER 1000	MURDER	RAPE	ROBBERY	FELONIOUS ASSAULT	BREAKING & ENTERING	LARCENY	MOTOR VEHICLE THEFT	ARSON
Nichols Hills Police Department 05505	2002	4,106	82	19.97				1	11	62	8	
	2001	4,056	37	9.12				1	8	25	3	
	2000	4,133	63	15.24			1	1	13	44	4	
Oklahoma City Police Department 05506	2002	512,448	49,929	97.43	38	445	1,169	2,562	8,314	33,686	3,715	193
	2001	506,132	45,875	90.64	45	405	1,090	2,643	8,405	29,771	3,516	202
	2000	488,431	47,845	97.96	38	388	990	2,535	7,280	33,012	3,602	216
Village Police Department 05507	2002	10,284	629	61.16		1	5	31	136	430	26	1
	2001	10,157	612	60.25			7	53	119	394	39	
	2000	10,524	758	72.03		3	10	55	117	548	25	2
Warr Acres Police Department 05508	2002	9,856	554	56.21		5	12	24	111	357	45	1
	2001	9,735	565	58.04	1	3	16	24	114	351	56	2
	2000	9,637	622	64.54	1	1	24	47	105	405	39	1
Choctaw Police Department 05510	2002	9,494	206	21.70		1		15	56	125	9	
	2001	9,377	187	19.94		1	4	15	45	120	2	4
	2000	10,263	200	19.49	1	3	2	16	69	100	9	
Harrah Police Department 05511	2002	4,778	125	26.16		1	1	8	37	74	4	2
	2001	4,719	130	27.55			1	21	39	63	6	1
	2000	5,145	96	18.66				4	26	57	9	1
Jones Police Department 05512	2002	2,549	35	13.73		1	1	4	8	14	7	
	2001	2,517	29	11.52				6	10	9	4	
	2000	2,538	29	11.43				3	16	7	3	
Luther Police Department 05513	2002	619	18	29.08				2	5	10	1	
	2001	612	42	68.63		1		4	26	10	1	
	2000	1,709	3	1.76					3			
Nicoma Park Police Department 05514	2002	2,445	51	20.86					13	31	7	
	2001	2,415	50	20.70				1	17	25	7	1
	2000	2,377	43	18.09		1			12	26	4	

OKLAHOMA STATE BUREAU OF INVESTIGATION

AGENCY	YEAR	POPULATION	TOTAL CRIME INDEX	CRIME RATE PER 1000	MURDER	RAPE	ROBBERY	FELONIOUS ASSAULT	BREAKING & ENTERING	LARCENY	MOTOR VEHICLE THEFT	ARSON
Spencer Police Department 05515	2002	3,793	69	18.19		1	1	3	12	47	5	1
	2001	3,746	56	14.95		3		9	8	27	9	1
	2000	4,096	128	31.25		1	3	19	34	57	14	1
Forest Park Police Department 05516	2002	Reported Through the County SO										
	2001	Reported Through the County SO										
	2000	1,284	12	9.35					1	7	4	
University of Central Oklahoma Police * 05517	2002	16,500	89	5.39			1		9	77	2	1
	2001	16,500	111	6.73				2	7	98	4	6
	2000	20,352	116	5.70		1	1	2	21	89	2	2
Okla Univ Health Sciences Center Police * 05518	2002	18,091	285	15.75			2	21	64	195	3	
	2001	17,346	213	12.28			2	9	34	167	1	1
	2000	12,068	180	14.92			1	3	12	160	4	1
Putnam City Campus Police * 05522	2002	21,291	112	5.26					4	106	2	2
	2001	21,000	93	4.43		1		1	4	84	3	2
	2000	20,876	123	5.89				1	9	111	2	
Capitol Patrol * 05599	2002	42,500	65	1.53			1	8	7	47	2	1
	2001	42,500	69	1.62			1	3	3	59	3	1
	2000	42,500	56	1.32				2	6	47	1	
OKLAHOMA COUNTY	2002	743,193	58,458	78.66	42	513	1,294	2,977	10,237	39,142	4,253	240
	2001	734,030	53,870	73.39	51	468	1,221	3,043	10,110	34,895	4,082	276
	2000	723,297	56,279	77.81	45	459	1,138	2,968	8,901	38,556	4,212	274
Okmulgee County Sheriff's Office 05600	2002	18,134	189	10.42		1		13	60	97	18	1
	2001	17,909	248	13.85	1	2	2	43	63	105	32	12
	2000	16,763	324	19.33	1	7	4	56	97	134	25	19
Henryetta Police Department 05601	2002	6,172	332	53.79		4		40	87	173	28	
	2001	6,096	412	67.59		6		44	93	235	34	4
	2000	6,224	379	60.89	1	5	1	48	65	243	16	3

OKLAHOMA STATE BUREAU OF INVESTIGATION

AGENCY	YEAR	POPULATION	TOTAL CRIME INDEX	CRIME RATE PER 1000	MURDER	RAPE	ROBBERY	FELONIOUS ASSAULT	BREAKING & ENTERING	LARCENY	MOTOR VEHICLE THEFT	ARSON
Okmulgee Police Department 05602	2002	13,184	687	52.11			10	48	152	444	33	
	2001	13,022	700	53.76	1	5	9	48	145	442	50	3
	2000	14,097	626	44.41		5	7	49	128	391	46	4
Beggs Police Department 05604	2002	1,381	47	34.03				3	6	31	7	
	2001	1,364	36	26.39				11	7	14	4	2
	2000	1,280	34	26.56				12	10	9	3	
Morris Police Department 05611	2002	1,310	22	16.79					6	14	2	
	2001	1,294	24	18.55					3	19	2	
	2000	1,494	34	22.76				1	8	24	1	
Okla State Univ/Okmulgee * 05616	2002	2,896	42	14.50		1			12	28	1	
	2001	2,676	63	23.54				1	13	47	2	
	2000	3,085	97	31.44		1		4	14	77	1	1
OKMULGEE COUNTY	2002	40,181	1,319	32.83		6	10	104	323	787	89	1
	2001	39,685	1,483	37.37	2	13	11	147	324	862	124	21
	2000	39,858	1,494	37.48	2	18	12	170	322	878	92	27
Osage County Sheriff's Office 05700	2002	26,034	561	21.55		12	6	50	197	260	36	9
	2001	25,713	559	21.74		16	1	61	211	234	36	11
	2000	23,385	517	22.11		8	2	32	163	283	29	17
Barnsdall Police Department 05701	2002	1,341	36	26.85				3	7	25	1	2
	2001	1,325	16	12.08					3	11	2	
	2000	1,225	33	26.94				2	6	24	1	
Fairfax Police Department 05702	2002	1,575	38	24.13		2		2	10	24		
	2001	1,555	36	23.15					15	19	2	1
	2000	1,655	31	18.73				3	9	15	4	
Hominy Police Department 05703	2002	2,616	79	30.20		2		25	16	33	3	
	2001	2,584	56	21.67		1		18	16	19	2	
	2000	3,208	71	22.13			1	11	18	37	4	

OKLAHOMA STATE BUREAU OF INVESTIGATION

AGENCY	YEAR	POPULATION	TOTAL CRIME INDEX	CRIME RATE PER 1000	MURDER	RAPE	ROBBERY	FELONIOUS ASSAULT	BREAKING & ENTERING	LARCENY	MOTOR VEHICLE THEFT	ARSON
Pawhuska Police Department 05704	2002	3,674	165	44.91				44	32	83	6	
	2001	3,629	111	30.59		2	1	23	30	44	11	1
	2000	3,706	134	36.16		1		16	27	76	14	1
OSAGE COUNTY	2002	35,240	879	24.94		16	6	124	262	425	46	11
	2001	34,806	778	22.35		19	2	102	275	327	53	13
	2000	33,179	786	23.69		9	3	64	223	435	52	18
Ottawa County Sheriff's Office 05800	2002	17,054	228	13.37		2		3	81	109	33	5
	2001	16,845	230	13.65	1	1		8	80	104	36	7
	2000	15,348	324	21.11	1	5	1	22	120	133	42	9
Commerce Police Department 05801	2002	2,679	64	23.89				2	14	44	4	2
	2001	2,645	34	12.85		1		1	11	19	2	
	2000	2,657	116	43.66		1	2	9	34	62	8	2
Miami Police Department 05802	2002	13,875	747	53.84	2	11	4	54	150	503	23	2
	2001	13,704	756	55.17		13	3	35	168	509	28	4
	2000	13,728	882	64.25		10	4	48	167	612	41	9
NE Oklahoma A&M College Police * 05815	2002	2,350	37	15.74		1		1	15	20		1
	2001	2,210	68	30.77		1		2	34	31		1
	2000	2,299	46	20.01		1		3	24	17	1	1
OTTAWA COUNTY	2002	33,608	1,076	32.02	2	14	4	60	260	676	60	10
	2001	33,194	1,088	32.78	1	16	3	46	293	663	66	12
	2000	31,733	1,368	43.11	1	17	7	82	345	824	92	21
Pawnee County Sheriff's Office 05900	2002	11,234	261	23.23		2	1	27	105	111	15	3
	2001	11,096	267	24.06	1		2	43	64	121	36	4
	2000	11,737	243	20.70				14	59	143	27	2
Cleveland Police Department 05901	2002	3,323	158	47.55		3	2	8	27	113	5	
	2001	3,282	137	41.74		1		10	27	93	6	2
	2000	3,092	121	39.13				3	19	90	9	

OKLAHOMA STATE BUREAU OF INVESTIGATION

AGENCY	YEAR	POPULATION	TOTAL CRIME INDEX	CRIME RATE PER 1000	MURDER	RAPE	ROBBERY	FELONIOUS ASSAULT	BREAKING & ENTERING	LARCENY	MOTOR VEHICLE THEFT	ARSON
Pawnee Police Department 05902	2002	2,258	45	19.93				9	14	17	5	
	2001	2,230	62	27.80		1		7	13	34	7	
	2000	2,164	50	23.11				2	14	30	4	
PAWNEE COUNTY	2002	16,815	464	27.59		5	3	44	146	241	25	3
	2001	16,608	466	28.06	1	2	2	60	104	248	49	6
	2000	16,993	414	24.36				19	92	263	40	2
Payne County Sheriff's Office 06000	2002	17,289	317	18.34	1	17	1	22	126	137	13	15
	2001	17,074	392	22.96	2	12	4	37	121	205	11	5
	2000	15,963	225	14.10		1	2	39	70	102	11	2
Cushing Police Department 06001	2002	8,476	427	50.38		1	3	23	122	257	21	1
	2001	8,371	311	37.15	1	4	1	19	96	173	17	4
	2000	8,152	297	36.43	2	2	1	32	78	178	4	9
Stillwater Police Department 06002	2002	39,552	1,432	36.21		24	7	66	262	1,005	68	3
	2001	39,065	1,369	35.04		11	13	61	292	931	61	8
	2000	39,504	1,287	32.58		13	14	83	242	895	40	6
Yale Police Department 06003	2002	1,358	18	13.25				4	2	11	1	1
	2001	1,342	43	32.04			1	3	12	24	3	
	2000	1,386	36	25.97				17	6	12	1	
Perkins Police Department 06006	2002	2,300	52	22.61				2	17	30	3	2
	2001	2,272	39	17.17				5	11	21	2	
	2000	2,148	51	23.74		1	1	14	12	21	2	
Oklahoma State University Police * 06010	2002	26,533	267	10.06		3	1	2	42	213	6	1
	2001	26,713	265	9.92		1		1	44	214	5	2
	2000	24,836	171	6.89		3		3	23	139	3	1
PAYNE COUNTY	2002	68,975	2,513	36.43	1	45	12	119	571	1,653	112	23
	2001	68,124	2,419	35.51	3	28	19	126	576	1,568	99	19
	2000	67,153	2,067	30.78	2	20	18	188	431	1,347	61	18

OKLAHOMA STATE BUREAU OF INVESTIGATION

AGENCY	YEAR	POPULATION	TOTAL CRIME INDEX	CRIME RATE PER 1000	MURDER	RAPE	ROBBERY	FELONIOUS ASSAULT	BREAKING & ENTERING	LARCENY	MOTOR VEHICLE THEFT	ARSON
Pittsburg County Sheriff's Office 06100	2002	21,389	416	19.45	2		1	6	161	198	48	1
	2001	21,126	463	21.92	1	1		35	172	212	42	3
	2000	21,555	374	17.35		2	1	42	124	180	25	7
Hartshorne Police Department 06101	2002	2,129	89	41.80				14	32	39	4	3
	2001	2,102	67	31.87				14	19	31	3	
	2000	2,229	93	41.72				11	35	39	8	2
McAlester Police Department 06102	2002	18,005	932	51.76		4	12	43	217	589	67	2
	2001	17,783	897	50.44		4	5	35	214	600	39	1
	2000	17,896	1,001	55.93	2	11	9	43	216	661	59	3
Haileyville Police Department 06114	2002	902	14	15.52				2	6	6		1
	2001	891	13	14.59					8	4	1	
	2000	966	7	7.25				2	2	1	2	1
Krebs Police Department 06118	2002	2,076	91	43.83		4		14	14	52	7	
	2001	2,051	88	42.91		1		5	21	58	3	
	2000	2,025	77	38.02		1		1	20	49	6	
PITTSBURG COUNTY	2002	44,501	1,542	34.65	2	8	13	79	430	884	126	7
	2001	43,953	1,528	34.76	1	6	5	89	434	905	88	4
	2000	44,671	1,552	34.74	2	14	10	99	397	930	100	13
Pontotoc County Sheriff's Office 06200	2002	19,695	178	9.04	3	3		6	63	83	20	3
	2001	19,452	148	7.61	2			14	48	76	8	5
	2000	19,954	160	8.02				8	75	71	6	1
Ada Police Department 06201	2002	15,887	994	62.57	3	13	5	69	226	630	48	9
	2001	15,691	956	60.93		10	10	69	207	621	39	2
	2000	15,689	911	58.07	4	4	9	125	226	513	30	4
East Central University Police Dept. * 06216	2002	4,798	33	6.88					11	22		
	2001	4,827	5	1.04					5			
	2000	4,500	21	4.67					3	17	1	

OKLAHOMA STATE BUREAU OF INVESTIGATION

AGENCY	YEAR	POPULATION	TOTAL CRIME INDEX	CRIME RATE PER 1000	MURDER	RAPE	ROBBERY	FELONIOUS ASSAULT	BREAKING & ENTERING	LARCENY	MOTOR VEHICLE THEFT	ARSON
PONTOTOC COUNTY	2002	35,582	1,205	33.87	6	16	5	75	300	735	68	12
	2001	35,143	1,109	31.56	2	10	10	83	260	697	47	7
	2000	35,643	1,092	30.64	4	4	9	133	304	601	37	5
Pottawatomie County Sheriff's Office 06300	2002	27,522	580	21.07	1	15	1	44	164	310	45	15
	2001	27,183	658	24.21		2	2	56	229	323	46	3
	2000	26,620	554	20.81	1	6	1	57	159	276	54	14
Shawnee Police Department 06301	2002	29,050	1,724	59.35		22	22	155	582	751	192	4
	2001	28,692	1,832	63.85	4	12	32	116	412	1,121	135	1
	2000	28,751	1,722	59.89	1	4	22	57	331	1,167	140	2
Tecumseh Police Department 06302	2002	6,174	254	41.14		3	3	40	57	142	9	
	2001	6,098	119	19.51		1	2	4	21	84	7	1
	2000	6,031	135	22.38		1	3	19	26	83	3	
McLoud Police Department 06314	2002	3,592	88	24.50		4	2	22	24	23	13	1
	2001	3,548	79	22.27				25	18	31	5	
	2000	2,980	99	33.22			1	20	22	49	7	
POTTAWATOMIE COUNTY	2002	66,338	2,646	39.89	1	44	28	261	827	1,226	259	20
	2001	65,521	2,688	41.03	4	15	36	201	680	1,559	193	5
	2000	64,382	2,510	38.99	2	11	27	153	538	1,575	204	16
Pushmataha County Sheriff's Office 06400	2002	8,501	209	24.59	1	2		27	77	74	28	5
	2001	8,396	172	20.49		2		35	69	48	18	3
	2000	8,493	99	11.66	1			14	27	50	7	4
Antlers Police Department 06401	2002	2,584	196	75.85		2		18	95	75	6	3
	2001	2,552	142	55.64		1	2	26	39	68	6	1
	2000	2,662	153	57.48			2	38	35	76	2	2
Clayton Police Department 06403	2002	728	29	39.84				8	7	12	2	
	2001	719	27	37.55				7	8	10	2	1
	2000	705	26	36.88				4	7	15		

OKLAHOMA STATE BUREAU OF INVESTIGATION

AGENCY	YEAR	POPULATION	TOTAL CRIME INDEX	CRIME RATE PER 1000	MURDER	RAPE	ROBBERY	FELONIOUS ASSAULT	BREAKING & ENTERING	LARCENY	MOTOR VEHICLE THEFT	ARSON
PUSHMATAHA COUNTY	2002	11,813	434	36.74	1	4		53	179	161	36	8
	2001	11,667	341	29.23		3	2	68	116	126	26	5
	2000	11,860	278	23.44	1		2	56	69	141	9	6
Roger Mills County Sheriff's Office 06500	2002	3,479	38	10.92				4	9	22	3	1
	2001	3,436	61	17.75	1			7	18	30	5	1
	2000	3,692	16	4.33				4	5	7		
ROGER MILLS COUNTY	2002	3,479	38	10.92				4	9	22	3	1
	2001	3,436	61	17.75	1			7	18	30	5	1
	2000	3,692	16	4.33				4	5	7		
Rogers County Sheriff's Office 06600	2002	46,823	326	6.96				13	98	165	50	
	2001	46,247	332	7.18	1			8	101	195	27	1
	2000	40,695	340	8.35			2	22	92	192	31	1
Claremore Police Department 06601	2002	16,071	623	38.77	1	8	2	46	79	449	38	2
	2001	15,873	730	45.99		7	6	35	122	517	43	3
	2000	22,382	669	29.89	1	9	7	39	115	443	55	1
Catoosa Police Department 06603	2002	5,517	192	34.80	1	3	3	11	44	105	25	
	2001	5,449	192	35.24		2	7	18	42	108	15	1
	2000	5,724	215	37.56		1	2	11	41	136	24	
Chelsea Police Department 06604	2002	2,163	86	39.76		4		4	11	58	9	
	2001	2,136	90	42.13				7	15	59	9	1
	2000	2,008	101	50.30		5		9	10	69	8	2
Inola Police Department 06606	2002	1,609	26	16.16		1			3	20	2	1
	2001	1,589	51	32.10		2		1	4	37	7	
	2000	1,732	37	21.36		1		3	18	14	1	
Oologah Police Department 06607	2002	894	41	45.86				6	6	25	4	1
	2001	883	35	39.64			1	3	8	21	2	
	2000	1,042	26	24.95				4	7	14	1	

OKLAHOMA STATE BUREAU OF INVESTIGATION

AGENCY	YEAR	POPULATION	TOTAL CRIME INDEX	CRIME RATE PER 1000	MURDER	RAPE	ROBBERY	FELONIOUS ASSAULT	BREAKING & ENTERING	LARCENY	MOTOR VEHICLE THEFT	ARSON
Rogers State University Police * 06613	2002	3,164	14	4.42					4	10		
	2001	3,084	8	2.59					2	6		
	2000	3,064	5	1.63					5			
ROGERS COUNTY	2002	73,077	1,308	17.90	2	16	5	80	245	832	128	4
	2001	72,177	1,438	19.92	1	11	14	72	294	943	103	6
	2000	73,583	1,393	18.93	1	18	10	88	288	868	120	4
Seminole County Sheriff's Office 06700	2002	13,116	244	18.60	2	4	2	20	107	82	27	10
	2001	12,954	241	18.60	1	3	2	18	94	118	5	4
	2000	12,815	167	13.03	1	1	2	39	58	55	11	5
Konawa Police Department 06701	2002	1,497	37	24.72	1			7	6	21	2	
	2001	1,479	38	25.69				15	4	13	6	
	2000	1,460	16	10.96				2	9	3	2	
Seminole Police Department 06702	2002	6,985	314	44.95	1	2	3	13	90	180	25	7
	2001	6,899	319	46.24		3	1	8	57	228	22	2
	2000	6,987	348	49.81		5	2	23	62	238	18	1
Wewoka Police Department 06703	2002	3,607	78	21.62			2	16	24	33	3	
	2001	3,562	80	22.46				11	29	36	4	
	2000	3,961	145	36.61				23	30	82	10	
Seminole State College * 06713	2002	2,074	26	12.54					3	23		
	2001	2,095	17	8.11					1	16		
	2000	2,056	20	9.73					3	17		
SEMINOLE COUNTY	2002	25,205	699	27.73	4	6	7	56	230	339	57	17
	2001	24,894	695	27.92	1	6	3	52	185	411	37	6
	2000	25,223	696	27.59	1	6	4	87	162	395	41	6
Sequoyah County Sheriff's Office 06800	2002	23,970	440	18.36	1	2	1	99	133	170	34	7
	2001	23,675	712	30.07		8	5	159	262	196	82	6
	2000	23,227	691	29.75	3	12	2	155	219	203	97	40

OKLAHOMA STATE BUREAU OF INVESTIGATION

AGENCY	YEAR	POPULATION	TOTAL CRIME INDEX	CRIME RATE PER 1000	MURDER	RAPE	ROBBERY	FELONIOUS ASSAULT	BREAKING & ENTERING	LARCENY	MOTOR VEHICLE THEFT	ARSON
Sallisaw Police Department 06801	2002	8,089	502	62.06	3	5	1	139	72	255	27	4
	2001	7,989	651	81.49		3	3	143	121	333	48	3
	2000	8,086	557	68.88		3	3	79	69	343	60	3
Muldrow Police Department 06812	2002	3,143	81	25.77		2		11	22	44	2	1
	2001	3,104	89	28.67			2	11	19	48	9	
	2000	3,394	79	23.28	1		2	6	22	40	8	
Roland Police Department 06814	2002	2,878	50	17.37		1	1	4	5	32	7	1
	2001	2,842	38	13.37			1	2	13	21	1	
	2000	2,781	56	20.14				2	11	37	6	
Vian Police Department 06816	2002	1,379	33	23.93		1		8	13	11		
	2001	1,362	100	73.42		1	1	16	35	40	7	
	2000	1,443	42	29.11		1	2	10	6	21	2	2
SEQUOYAH COUNTY	2002	39,459	1,106	28.03	4	11	3	261	245	512	70	13
	2001	38,972	1,590	40.80		12	12	331	450	638	147	9
	2000	38,931	1,425	36.60	4	16	9	252	327	644	173	45
Stephens County Sheriff's Office 06900	2002	14,711	178	12.10		1		28	31	107	11	
	2001	14,529	212	14.59		1		13	62	126	10	1
	2000	15,448	205	13.27	1	1	1		50	137	15	3
Comanche Police Department 06901	2002	1,576	39	24.75		3		8	5	21	2	1
	2001	1,556	35	22.49		1		5	7	19	3	1
	2000	1,750	33	18.86				3	10	19	1	
Duncan Police Department 06902	2002	22,785	1,139	49.99		10	6	41	185	846	51	4
	2001	22,505	1,142	50.74		6	6	32	268	786	44	4
	2000	22,396	1,069	47.73	1	5	15	57	211	757	23	4
Marlow Police Department 06903	2002	4,649	107	23.02				1	25	78	3	
	2001	4,592	78	16.99				2	13	57	6	
	2000	4,670	136	29.12			1	2	24	107	2	2

OKLAHOMA STATE BUREAU OF INVESTIGATION

AGENCY	YEAR	POPULATION	TOTAL CRIME INDEX	CRIME RATE PER 1000	MURDER	RAPE	ROBBERY	FELONIOUS ASSAULT	BREAKING & ENTERING	LARCENY	MOTOR VEHICLE THEFT	ARSON
STEPHENS COUNTY	2002	43,721	1,463	33.46		14	6	78	246	1,052	67	5
	2001	43,182	1,467	33.97		8	6	52	350	988	63	6
	2000	44,264	1,443	32.60	2	6	17	62	295	1,020	41	9
Texas County Sheriff's Office 07000	2002	6,738	81	12.02		1		10	22	44	4	1
	2001	6,655	74	11.12		1		10	16	43	4	1
	2000	7,013	92	13.12		6		21	25	40		1
Guymon Police Department 07001	2002	10,602	345	32.54		4	1	10	40	267	23	
	2001	10,472	360	34.38		6	1	11	63	257	22	1
	2000	9,167	411	44.83		6	4	32	75	276	18	3
Hooker Police Department 07002	2002	1,811	14	7.73					4	9	1	
	2001	1,788	15	8.39					3	10	2	
	2000	1,638	21	12.82				1	8	12		
Goodwell Police Department 07006	2002	1,207	37	30.65					23	13	1	1
	2001	1,192	20	16.78					12	8		
	2000	1,016	25	24.61				2	15	8		
TEXAS COUNTY	2002	20,358	477	23.43		5	1	20	89	333	29	2
	2001	20,107	469	23.33		7	1	21	94	318	28	2
	2000	18,834	549	29.15		12	4	56	123	336	18	4
Tillman County Sheriff's Office 07100	2002	4,709	37	7.86		2		2	11	22		
	2001	4,650	39	8.39		1		4	11	20	3	
	2000	4,888	41	8.39				2	15	23	1	
Frederick Police Department 07101	2002	4,694	156	33.23		1	3	14	42	88	8	3
	2001	4,637	158	34.07		5	2	14	31	102	4	
	2000	4,791	178	37.15		1	1	20	44	110	2	
TILLMAN COUNTY	2002	9,403	193	20.53		3	3	16	53	110	8	3
	2001	9,287	197	21.21		6	2	18	42	122	7	
	2000	9,679	219	22.63		1	1	22	59	133	3	

OKLAHOMA STATE BUREAU OF INVESTIGATION

AGENCY	YEAR	POPULATION	TOTAL CRIME INDEX	CRIME RATE PER 1000	MURDER	RAPE	ROBBERY	FELONIOUS ASSAULT	BREAKING & ENTERING	LARCENY	MOTOR VEHICLE THEFT	ARSON
Tulsa County Sheriff's Office 07200	2002	36,210	1,618	44.68	3	14	30	185	323	891	172	9
	2001	35,763	1,728	48.32	3	14	29	218	360	934	170	9
	2000	36,187	1,365	37.72	3	15	32	173	252	754	136	12
Broken Arrow Police Department 07201	2002	75,794	2,281	30.09	3	31	24	108	427	1,532	156	
	2001	74,859	2,310	30.86	1	35	21	125	453	1,516	159	8
	2000	77,414	2,224	28.73	2	20	14	94	424	1,500	170	13
Collinsville Police Department 07202	2002	4,128	111	26.89			1	7	40	54	9	
	2001	4,077	119	29.19	1		1	6	33	66	12	
	2000	4,252	132	31.04		2		13	47	63	7	1
Sand Springs Police Department 07203	2002	17,669	704	39.84		9	14	33	128	451	69	5
	2001	17,451	628	35.99		7	6	19	93	438	65	4
	2000	18,942	658	34.74		4	6	18	118	433	79	1
Skiatook Police Department 07204	2002	5,464	219	40.08				6	51	147	15	
	2001	5,396	245	45.40		1		9	56	167	12	
	2000	5,828	237	40.67		2	1	10	43	173	8	1
Tulsa Police Department 07205	2002	397,953	30,119	75.68	26	243	901	3,153	6,313	15,918	3,565	229
	2001	393,049	29,354	74.68	34	256	776	3,481	5,863	15,308	3,636	250
	2000	392,102	26,853	68.48	33	242	737	3,399	5,383	13,677	3,382	257
Bixby Police Department 07206	2002	13,502	370	27.40	1	2	5	25	64	239	34	7
	2001	13,336	310	23.25		3	3	13	55	208	28	4
	2000	13,644	323	23.67		4	3	8	52	221	35	5
Glenpool Police Department 07207	2002	8,225	136	16.53		1	1		37	91	6	
	2001	8,123	122	15.02		1	1		28	81	11	
	2000	8,493	152	17.90	1	1		5	40	84	21	
Jenks Police Department 07208	2002	9,676	174	17.98		1	1	11	54	104	3	
	2001	9,557	164	17.16	1	3		4	24	119	13	
	2000	9,971	161	16.15					19	125	17	

OKLAHOMA STATE BUREAU OF INVESTIGATION

AGENCY	YEAR	POPULATION	TOTAL CRIME INDEX	CRIME RATE PER 1000	MURDER	RAPE	ROBBERY	FELONIOUS ASSAULT	BREAKING & ENTERING	LARCENY	MOTOR VEHICLE THEFT	ARSON
Owasso Police Department 07210	2002	18,732	645	34.43		4	5	30	94	462	50	5
	2001	18,502	641	34.64		6	4	37	104	451	39	2
	2000	16,734	488	29.16	1	11	9	22	89	310	46	3
Tulsa Community College Police * 07212	2002	29,079	56	1.93				1		52	3	
	2001	22,386	53	2.37						53		
	2000	20,812	61	2.93					3	58		
Okla State Univ/Tulsa * 07214	2002	9,027	25	2.77					1	22	2	
	2001	7,928	31	3.91				1	3	23	4	
	2000	8,793	25	2.84						21	4	
TULSA COUNTY	2002	587,353	36,458	62.07	33	305	982	3,559	7,532	19,963	4,084	255
	2001	580,113	35,705	61.55	40	326	841	3,913	7,072	19,364	4,149	277
	2000	583,567	32,679	56.00	40	301	802	3,742	6,470	17,419	3,905	293
Wagoner County Sheriff's Office 07300	2002	34,362	423	12.31	1	6	1	25	138	192	60	9
	2001	33,939	438	12.91	1	3	4	22	125	217	66	1
	2000	32,111	458	14.26	2	3	2	14	124	244	69	8
Wagoner Police Department 07301	2002	7,765	353	45.46		2	6	25	71	236	13	2
	2001	7,669	309	40.29	1	1	5	19	66	207	10	2
	2000	7,596	382	50.29		1	6	22	83	252	18	
Coweta Police Department 07303	2002	7,228	210	29.05			1	5	47	146	11	1
	2001	7,139	210	29.42		1	2	6	42	139	20	2
	2000	7,584	195	25.71	1		2	10	44	125	13	8
WAGONER COUNTY	2002	49,355	986	19.98	1	8	8	55	256	574	84	12
	2001	48,747	957	19.63	2	5	11	47	233	563	96	5
	2000	47,291	1,035	21.89	3	4	10	46	251	621	100	16
Washington County Sheriff's Office 07400	2002	11,210	227	20.25		1	2	25	69	112	18	10
	2001	11,071	180	16.26		7		19	40	101	13	5
	2000	11,013	203	18.43		5	2	20	55	100	21	6

OKLAHOMA STATE BUREAU OF INVESTIGATION

AGENCY	YEAR	POPULATION	TOTAL CRIME INDEX	CRIME RATE PER 1000	MURDER	RAPE	ROBBERY	FELONIOUS ASSAULT	BREAKING & ENTERING	LARCENY	MOTOR VEHICLE THEFT	ARSON
Bartlesville Police Department 07401	2002	35,182	1,592	45.25	1	20	15	92	305	1,079	80	1
	2001	34,748	1,518	43.69		21	14	110	273	1,017	83	2
	2000	34,622	1,512	43.67	1	6	12	136	248	1,036	73	6
Dewey Police Department 07402	2002	3,218	153	47.55		1	2	13	33	100	4	1
	2001	3,179	119	37.43		1		8	23	80	7	3
	2000	3,382	134	39.62	1	5		15	25	82	6	3
WASHINGTON COUNTY	2002	49,610	1,972	39.75	1	22	19	130	407	1,291	102	12
	2001	48,998	1,817	37.08		29	14	137	336	1,198	103	10
	2000	49,017	1,849	37.72	2	16	14	171	328	1,218	100	15
Washita County Sheriff's Office 07500	2002	8,754	65	7.43				2	22	37	4	1
	2001	8,639	76	8.80					29	44	3	
	2000	9,218	62	6.73				1	17	39	5	
Cordell Police Department 07501	2002	2,895	54	18.65				16	5	31	2	
	2001	2,867	46	16.04				6	1	39		
	2000	2,787	57	20.45				6	8	42	1	
WASHITA COUNTY	2002	11,649	119	10.22				18	27	68	6	1
	2001	11,506	122	10.60				6	30	83	3	
	2000	12,005	119	9.91				7	25	81	6	
Woods County Sheriff's Office 07600	2002	2,844	23	8.09					5	17	1	1
	2001	2,808	21	7.48		1		2	6	12		1
	2000	2,462	61	24.78		3	1	2	23	29	3	1
Alva Police Department 07601	2002	5,354	85	15.88				11	23	51		1
	2001	5,288	160	30.26		1		15	34	104	6	
	2000	5,103	169	33.12				21	25	117	6	4
Waynoka Police Department 07602	2002	1,005	20	19.90		1		4	7	8		
	2001	993	23	23.16				9	3	9	2	
	2000	831	41	49.34		1		11	6	21	2	

OKLAHOMA STATE BUREAU OF INVESTIGATION

AGENCY	YEAR	POPULATION	TOTAL CRIME INDEX	CRIME RATE PER 1000	MURDER	RAPE	ROBBERY	FELONIOUS ASSAULT	BREAKING & ENTERING	LARCENY	MOTOR VEHICLE THEFT	ARSON
WOODS COUNTY	2002	9,203	128	13.91		1		15	35	76	1	2
	2001	9,089	204	22.44		2		26	43	125	8	1
	2000	8,396	271	32.28		4	1	34	54	167	11	5
Woodward County Sheriff's Office 07700	2002	5,473	75	13.70				7	28	36	4	1
	2001	5,407	107	19.79		1	1	16	26	55	8	1
	2000	5,423	122	22.50				10	56	50	6	2
Woodward Police Department 07701	2002	12,001	628	52.33		14	1	90	152	349	22	1
	2001	11,853	638	53.83		8	2	104	149	352	23	2
	2000	12,521	599	47.84		11	2	67	155	347	17	1
Mooreland Police Department 07705	2002	1,242	21	16.91				6	7	8		
	2001	1,226	10	8.16		1			2	6	1	
	2000	1,157	17	14.69		1			2	13	1	
WOODWARD COUNTY	2002	18,716	724	38.68		14	1	103	187	393	26	2
	2001	18,486	755	40.84		10	3	120	177	413	32	3
	2000	19,101	738	38.64		12	2	77	213	410	24	3
STATE TOTAL	2002	3,493,714	165,715	47.43	163	1,573	2,966	12,885	35,171	100,185	12,772	1,121
	2001	3,450,654	159,389	46.19	185	1,486	2,746	13,308	34,569	94,527	12,568	1,106
	2000	3,450,654	157,301	45.59	181	1,422	2,615	12,958	31,661	96,116	12,348	1,286

* Campus enrollment is not included in the state's population total; it is used to tabulate the crime rate only.

Please Note: The Arson offenses in this contributor report have not been included in the Total Crime Index or Crime Rate Per 1,000 figures.

X

CONTRIBUTOR
PARTICIPATION

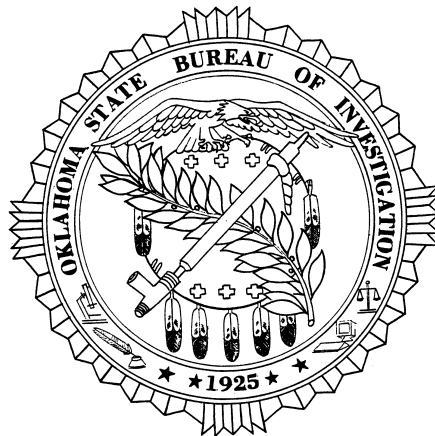

OKLAHOMA STATE BUREAU OF INVESTIGATION

HISTORY OF PROGRAM PARTICIPATION

There are approximately 450 sheriffs' offices and police departments in Oklahoma. During 1973, an average of 65 law enforcement agencies contributed monthly Uniform Crime Reports directly to the Federal Bureau of Investigation.

The Oklahoma State Bureau of Investigation assumed the statewide administration of the Uniform Crime Reporting Program on September 1, 1973. Since that time, an astounding increase in the number of agencies who report directly to the Oklahoma State Bureau of Investigation has been realized.

The table below sets forth the number of law enforcement agencies, by type, that have participated in the Oklahoma Uniform Crime Reporting Program for the years 2000, 2001, and 2002.

CONTRIBUTOR HISTORY

MONTH	TOTAL CONTRIBUTORS			POLICE DEPARTMENTS			SHERIFFS' OFFICES		
	2002	2001	2000	2002	2001	2000	2002	2001	2000
JAN	301	299	302	224	222	225	77	77	77
FEB	301	299	302	224	222	225	77	77	77
MAR	301	299	302	224	222	225	77	77	77
APR	301	299	302	224	222	225	77	77	77
MAY	301	299	302	224	222	225	77	77	77
JUN	301	299	302	224	222	225	77	77	77
JUL	301	299	302	224	222	225	77	77	77
AUG	301	299	302	224	222	225	77	77	77
SEP	301	299	302	224	222	225	77	77	77
OCT	301	299	302	224	222	225	77	77	77
NOV	301	299	302	224	222	225	77	77	77
DEC	301	299	302	224	222	225	77	77	77

XI

STATEMENT OF

POLICY AND

REGULATIONS

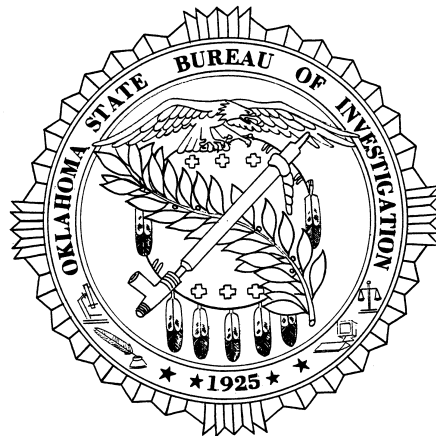

STATEMENT OF POLICY

The following regulations will be observed by this agency concerning the release of Uniform Crime Reporting statistical information. Employees of the agency will observe these procedures and will not deviate from this policy without the express consent of the Director of the Oklahoma State Bureau of Investigation. All information to be released will originate from the Field Services Unit of the Oklahoma State Bureau of Investigation.

REGULATIONS

1. This agency will publish an annual report reflecting the crime in Oklahoma. This report will be distributed to the Governor, to members of the Legislature, to the Attorney General, to law enforcement agencies, to the State Library System, and to any agency or committee dedicated to law enforcement or criminal justice work.
2. Published annual reports will be released to the above named agencies at no charge. They will then be released to individuals or agencies extraneous to the criminal justice community who shall pay a fee of five dollars (\$5.00) for every copy received.
3. UCR Information Requests:
 - A. Information contained in the published annual report may be released via telephone, letter, etc., to any interested party.
 - B. All requests for unpublished information from agencies or individuals extraneous to the criminal justice community should be submitted on an OSBI OPEN RECORDS ACT REQUEST FORM (ORA-1.) In accordance with the Oklahoma Open Records Act, all requests may be subject to a charge.
 - C. Law enforcement agencies may receive interim, unpublished, specialized reports identifying their agency only, provided the request is reasonable. Law enforcement agencies may also receive their respective county totals along with state or regional totals. All requests should be directed to the Supervisor of the Field Services Unit.

XII
APPENDIX

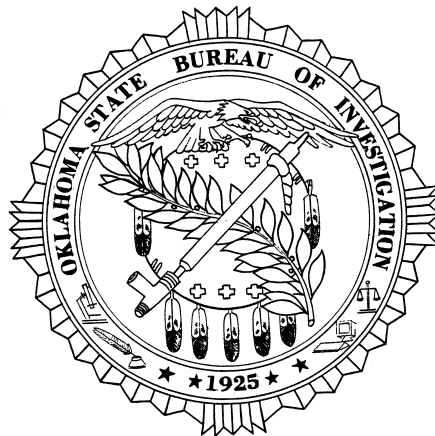

STATISTICAL VARIABLES

From the Uniform Crime Reporting (UCR) Program's inception, it was obvious the quality of the program would be limited since it would not be possible to account for every crime. When analyzing UCR data, it must be remembered that these statistics are based upon offenses reported or known to the police.

Citizens do not report crimes in many instances for various reasons. Victims may consider the offenses to be of little consequence; they believe there is nothing the police can do about them; or they fear retaliation from offenders because they have shared willingly in such offenses as illegal sex acts, gambling, or drug use. Consequently, some offenses are never entered into the present statistical reporting system. A national survey conducted for the President's Commission on Law Enforcement and Administration of Justice indicates half of the victimizations which occur are not reported to law enforcement authorities.

In some cases, law enforcement agencies themselves question the merit of the UCR Program. A common complaint concerns jurisdiction when a sheriff's department is called upon to investigate a crime within the city limits and makes an arrest in connection with that offense. The sheriff's department feels it is necessary to score the offense but, under UCR guidelines, the city must report the offense, the clearance, and the arrest. It must be remembered that Uniform Crime Reports are collected for the purpose of measuring the extent and type of crime by geographical location; they are not activity reports.

The crime information gathered and disseminated by this report is the most accurate currently available in Oklahoma. Caution has been and will continue to be exercised when direct statistical comparisons are suggested, primarily because of a great number of socioeconomic issues. Likewise, when comparing offenses and arrest data, it should be remembered that crimes relate to events, while arrests relate to people. A single crime may involve several offenses, multiple offenders and/or victims.

Some additional conditions which will, by type and volume, affect the crime that occurs from place to place are outlined below. These same conditions will also affect the amount of crime actually reported.

1. Density and size of the community population and the metropolitan area of which it is a part.
2. Composition of the population, particularly in reference to age, sex, and race.
3. Economic status and mores of the population.
4. Relative stability of population, including commuters, seasonal and other transient types.

5. Climate, including seasonal weather conditions.
6. Educational, recreational, and religious characteristics.
7. Effective strength of the police force.
8. Standards governing appointment to the police force.
9. Policies of the prosecuting officials and the courts.
10. Attitude of the public toward law enforcement problems.
11. The administrative and investigative efficiency of the local law enforcement agency, including the degree of adherence to reporting crime statistics.

Because they are influenced by many variables, current methods of gathering and reporting offenses and arrest data provide a less than complete picture of criminality in our society. However, an alternative information system, which can overcome the present program's shortcomings and more adequately perform this task, is currently unavailable.

GLOSSARY OF TERMS

ADULT - For Uniform Crime Reporting purposes, a person 18 years of age or more.

ARREST RATE - The number of arrests reported for Part I and Part II offenses for each unit of population, generally per 100,000. Arrest rates are computed in the same manner as crime rates.

CLEARANCE RATE - The number of clearances reported for Part I offenses. This rate is determined by dividing the number of clearances by the number of offenses.

CLEARED BY ARREST - For UCR purposes, an offense is cleared by arrest or solved when at least one person is (1) arrested, (2) charged with the commission of the offense, and (3) turned over for prosecution.

CRIME FACTORS - Conditions which affect the amount and type of crime that occurs in a geographical area.

CRIME INDEX - The sum total of the seven major offenses used to measure the extent, fluctuation, and distribution of crime in a given geographical area. Crime classifications used in the index are: (1) murder, (2) forcible rape, (3) robbery, (4) felonious assault, (5) breaking and entering, (6) larceny (theft), and (7) motor vehicle theft. Each of these offenses is referred to as an "index crime."

CRIME RATE - The number of index offenses reported for each unit of population, generally 100,000. Crime rates are computed for communities by dividing the number of index crimes by the population and multiplying the answer by 100,000.

EXCEPTIONAL CLEARANCE - A crime solution or clearance recorded when some element beyond law enforcement control precludes the placing of formal charges against the offender.

JUVENILE - For UCR purposes, a person under the age of 18.

NON-VIOLENT CRIME - Consists of the index crimes of breaking and entering, larceny (theft) and motor vehicle theft.

PART I OFFENSES - The first of two main categories of crime classes comprising a universal crime classification system established for crime reporting purposes. Part I offenses are by their nature more serious and/or occur with greater frequency. The monthly tabulation of Part I offenses provides a count of "offenses known."

PART II OFFENSES - The second of two main categories of crime classes comprising a universal crime classification system established for crime reporting purposes. Part II offenses are generally less serious in nature and/or occur less frequently. Monthly tabulations of Part II offenses are limited to arrest information only.

VIOLENT CRIME - Consists of the index crimes of murder, rape, robbery, and aggravated assault.

